

## Errata

**Title & Document Type:** 8903E Operation & Calibration  
Manual

**Manual Part Number:** 08903-90053

**Revision Date:** July 1985

---

### HP References in this Manual

This manual may contain references to HP or Hewlett-Packard. Please note that Hewlett-Packard's former test and measurement, semiconductor products and chemical analysis businesses are now part of Agilent Technologies. We have made no changes to this manual copy. The HP XXXX referred to in this document is now the Agilent XXXX. For example, model number HP8648A is now model number Agilent 8648A.

### About this Manual

We've added this manual to the Agilent website in an effort to help you support your product. This manual provides the best information we could find. It may be incomplete or contain dated information, and the scan quality may not be ideal. If we find a better copy in the future, we will add it to the Agilent website.

### Support for Your Product

Agilent no longer sells or supports this product. You will find any other available product information on the Agilent Test & Measurement website:

[www.tm.agilent.com](http://www.tm.agilent.com)

Search for the model number of this product, and the resulting product page will guide you to any available information. Our service centers may be able to perform calibration if no repair parts are needed, but no other support from Agilent is available.

# HP 8903E Distortion Analyzer

Operation and  
Calibration Manual

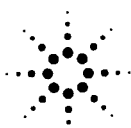
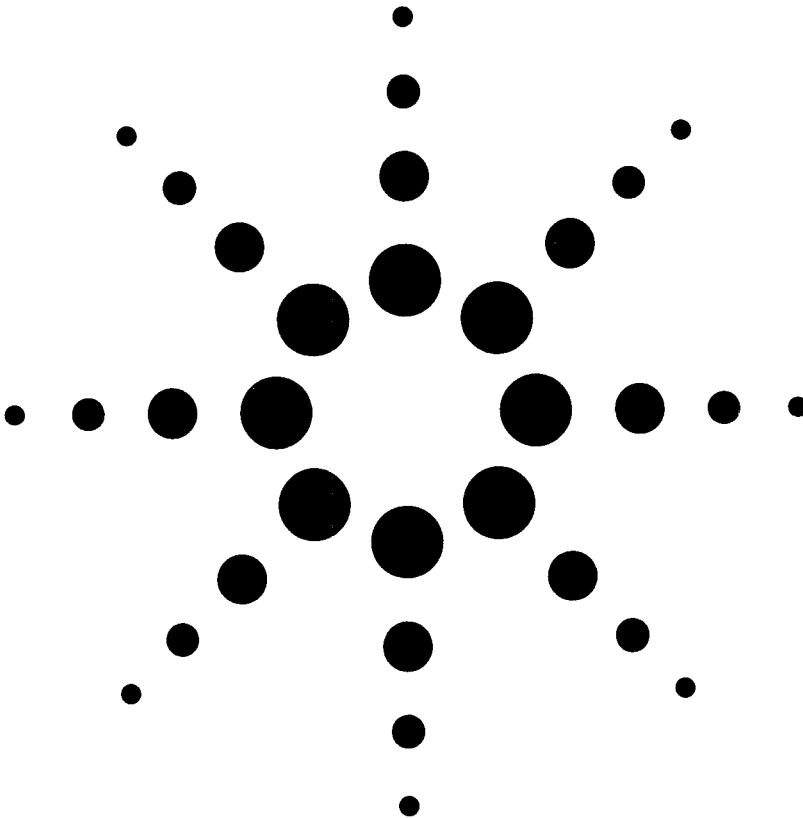

Agilent Technologies

# HP 8903E DISTORTION ANALYZER

(Including Option 001)

## SERIAL NUMBERS

This manual applies directly to instruments with serial numbers prefixed 2507A and 2516A.

For additional important information about serial numbers, see *Instruments Covered by Manual* in Section 1.

First Edition

©HEWLETT-PACKARD COMPANY 1985  
EAST 24001 MISSION AVENUE, TAF C-34, SPOKANE, WASHINGTON, U.S.A., 99220

Operation and Calibration Manual Part No. 08903-90053  
Operation and Calibration Manual Microfiche Part No. 90069

Printed: JULY 1985



HEWLETT  
PACKARD

---

# **1 Regulatory Information**

(Updated March 1999)

## Safety Considerations

### GENERAL

This product and related documentation must be reviewed for familiarization with safety markings and instructions before operation.

This product has been designed and tested in accordance with *IEC Publication 1010*, "Safety Requirements for Electronic Measuring Apparatus," and has been supplied in a safe condition. This instruction documentation contains information and warnings which must be followed by the user to ensure safe operation and to maintain the product in a safe condition.

### SAFETY EARTH GROUND

A uninterruptible safety earth ground must be provided from the main power source to the product input wiring terminals, power cord, or supplied power cord set.

### SAFETY SYMBOLS



Indicates instrument damage can occur if indicated operating limits are exceeded.



Indicates hazardous voltages.



Indicates earth (ground) terminal

---

**WARNING**    **A WARNING note denotes a hazard. It calls attention to a procedure, practice, or the like, which, if not correctly performed or adhered to, could result in personal injury. Do not proceed beyond a WARNING sign until the indicated conditions are fully understood and met.**

---

---

**CAUTION**    A CAUTION note denotes a hazard. It calls attention to an operation procedure, practice, or the like, which, if not correctly performed or adhered to, could result in damage to or destruction of part or all of the product. Do not proceed beyond an CAUTION note until the indicated conditions are fully understood and met.

---

## Safety Considerations for this Instrument

---

**WARNING** This product is a Safety Class I instrument (provided with a protective earthing ground incorporated in the power cord). The mains plug shall only be inserted in a socket outlet provided with a protective earth contact. Any interruption of the protective conductor inside or outside of the product is likely to make the product dangerous. Intentional interruption is prohibited.

Whenever it is likely that the protection has been impaired, the instrument must be made inoperative and be secured against any unintended operation.

If this instrument is to be energized via an auto transformer (for voltage reduction), make sure the common terminal is connected to the earth terminal of the power source.

If this product is not used as specified, the protection provided by the equipment could be impaired. This product must be used in a normal condition (in which all means for protection are intact) only.

No operator serviceable parts in this product. Refer servicing to qualified personnel. To prevent electrical shock, do not remove covers.

Servicing instructions are for use by qualified personnel only. To avoid electrical shock, do not perform any servicing unless you are qualified to do so.

The opening of covers or removal of parts is likely to expose dangerous voltages. Disconnect the product from all voltage sources while it is being opened.

The power cord is connected to internal capacitors that may remain live for 5 seconds after disconnecting the plug from its power supply.

For Continued protection against fire hazard, replace the line fuse(s) only with 250 V fuse(s) or the same current rating and type (for example, normal blow or time delay). Do not use repaired fuses or short circuited fuseholders.

Always use the three-prong ac power cord supplied with this product. Failure to ensure adequate earth grounding by not using this cord may cause product damage.

This product is designed for use in Installation Category II and Pollution Degree 2 per IEC 1010 and IEC 664 respectively. FOR INDOOR USE ONLY.

This product has autoranging line voltage input, be sure the supply voltage is within the specified range.

**To prevent electrical shock, disconnect instrument from mains (line) before cleaning. Use a dry cloth or one slightly dampened with water to clean the external case parts. Do not attempt to clean internally.**

**Ventilation Requirements: When installing the product in a cabinet, the convection into and out of the product must not be restricted. The ambient temperature (outside the cabinet) must be less than the maximum operating temperature of the product by 4° C for every 100 watts dissipated in the cabinet. If the total power dissipated in the cabinet is greater than 800 watts, then forced convection must be used.**

---

### **Product Markings**

CE - the CE mark is a registered trademark of the European Community. A CE mark accompanied by a year indicated the year the design was proven.

CSA - the CSA mark is a registered trademark of the Canadian Standards Association.

## SAFETY CONSIDERATIONS

### GENERAL

This product and related documentation must be reviewed for familiarization with safety markings and instructions before operation.

This product is a Safety Class I instrument (provided with a protective earth terminal).

### BEFORE APPLYING POWER

Verify that the product is set to match the available line voltage and the correct fuse is installed.

### SAFETY EARTH GROUND

An uninterruptible safety earth ground must be provided from the main power source to the product input wiring terminals, power cord, or supplied power cord set.

### SAFETY SYMBOLS



Instruction manual symbol: the product will be marked with this symbol when it is necessary for the user to refer to the instruction manual (refer to Table of Contents).



Indicates hazardous voltages.



Indicates earth (ground) terminal.

#### WARNING

The WARNING sign denotes a hazard. It calls attention to a procedure, practice, or the like, which, if not correctly performed or adhered to, could result in personal injury. Do not proceed beyond a WARNING sign until the indicated conditions are fully understood and met.

#### CAUTION

The CAUTION sign denotes a hazard. It calls attention to an operating procedure, practice, or the like, which, if not correctly performed or adhered to, could result in damage to or destruction of part or all of the product. Do not proceed beyond a CAUTION sign until the indicated conditions are fully understood and met.

#### WARNING

*Any interruption of the protective (grounding) conductor (inside or outside the instrument) or disconnecting the protective earth terminal will cause a potential shock hazard that could result in personal injury. (Grounding one conductor of a two conductor outlet is not sufficient protection).*

*Whenever it is likely that the protection has been impaired, the instrument must be made inoperative and be secured against any unintended operation.*

*If this instrument is to be energized via an autotransformer (for voltage reduction) make sure the common terminal is connected to the earth terminal of the power source.*

*Servicing instructions are for use by service-trained personnel only. To avoid dangerous electric shock, do not perform any servicing unless qualified to do so.*

*Adjustments described in the manual are performed with power supplied to the instrument while protective covers are removed. Energy available at many points may, if contacted, result in personal injury.*

*Capacitors inside the instrument may still be charged even if the instrument has been disconnected from its source of supply.*

*For continued protection against fire hazard, replace the line fuse(s) only with 250V fuse(s) of the same current rating and type (for example, normal blow, time delay, etc.). Do not use repaired fuses or short circuited fuseholders.*



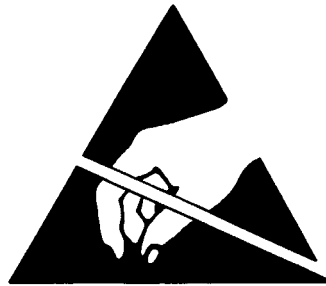

**ATTENTION  
Static Sensitive  
Devices**

*This instrument was constructed in an ESD (electro-static discharge) protected environment. This is because most of the semiconductor devices used in this instrument are susceptible to damage by static discharge.*

*Depending on the magnitude of the charge, device substrates can be punctured or destroyed by contact or mere proximity of a static charge. The results can cause degradation of device performance, early failure, or immediate destruction.*

*These charges are generated in numerous ways such as simple contact, separation of materials, and normal motions of persons working with static sensitive devices.*

*When handling or servicing equipment containing static sensitive devices, adequate precautions must be taken to prevent device damage or destruction.*

*Only those who are thoroughly familiar with industry accepted techniques for handling static sensitive devices should attempt to service circuitry with these devices.*

*In all instances, measures must be taken to prevent static charge build-up on work surfaces and persons handling the devices.*

*For further information on ESD precautions, refer to "SPECIAL HANDLING CONSIDERATIONS FOR STATIC SENSITIVE DEVICES" in Section VIII Service Section.*

# CONTENTS

<b>VOLUME 1</b>	<u>Page</u>		<u>Page</u>
<b>Section 1</b>		<b>Section 2</b>	
<b>GENERAL INFORMATION</b>		<b>INSTALLATION</b>	
Introduction .....	1-1	Introduction .....	2-1
Specifications .....	1-1	Initial Inspection .....	2-1
Safety Considerations .....	1-1	Preparation for Use .....	2-1
Instruments Covered by Manual .....	1-1	Power Requirements .....	2-1
Serial Numbers .....	1-1	Line Voltage and Fuse Selection .....	2-1
Options .....	1-2	Power Cables .....	2-1
Manual Changes Supplement .....	1-2	HP-IB Address Selection .....	2-2
Description .....	1-2	Interconnections .....	2-4
General .....	1-2	Mating Connectors .....	2-4
Audio Testing .....	1-2	Interface Connector .....	2-4
Balanced Input .....	1-2	Coaxial Connectors .....	2-4
Transceiver Testing .....	1-3	Operating Environment .....	2-4
Systems .....	1-3	Bench Operation .....	2-5
Options .....	1-3	Rack Mounting .....	2-5
Electrical Options .....	1-3	Storage and Shipment .....	2-5
Electrical Option 001 .....	1-3	Environment .....	2-5
Internal Plug-in Filter Options .....	1-3	Packaging .....	2-5
Mechanical Options .....	1-4	Original Packaging .....	2-5
Front Handle Kit (Option 907) .....	1-4	Other Packaging .....	2-5
Rack Flange Kit (Option 908) .....	1-4		
Rack Flange and Front Handle		<b>Section 3</b>	
Combination Kit (Option 909) .....	1-4	<b>OPERATION</b>	
Hewlett-Packard Interface		Introduction .....	3-1
Bus (HP-IB) .....	1-4	General .....	3-1
Compatibility .....	1-4	Operating Characteristics .....	3-1
Selecting the HP-IB Address .....	1-4	Turn-On Procedure .....	3-1
Accessories Supplied .....	1-4	Local Operation .....	3-1
Electrical Equipment Available .....	1-4	Simplified Operation .....	3-2
HP-IB Controllers .....	1-4	Panel Features .....	3-2
Front-to-Rear-Panel Connectors		Detailed Operating Instructions .....	3-2
Retrofit Kit .....	1-4	Supplemental Information .....	3-2
Rear-to-Front-Panel Connectors		Remote Operation (HP-IB) .....	3-2
Retrofit Kit .....	1-6	Operator's Checks .....	3-2
Mechanical Equipment		Basic Functional Checks .....	3-2
Available .....	1-6	HP-IB Functional Checks .....	3-2
Chassis Slide Mount Kit .....	1-6	Operator's Maintenance .....	3-2
Chassis Tilt Slide Mount Kit .....	1-6	Operator's Checks .....	3-8
Recommended Test Equipment .....	1-6	Basic Functional Checks .....	3-8
Principles of Operation for		Preliminary Check .....	3-8
Simplified Block Diagram .....	1-6	Filter Check .....	3-9
Voltmeter and Notch Filter .....	1-6	Distortion .....	3-10
Counter .....	1-7	SINAD Check .....	3-10
Voltage Measurement .....	1-8	DC Level Check .....	3-10
Input Frequency Measurement .....	1-8	HP-IB Functional Checks .....	3-11
Controller .....	1-8	Address Recognition .....	3-11
Basics of Audio Measurements .....	1-8	Remote and Local Messages and the LCL Key .....	3-12
AC Level .....	1-8	Sending the Data Message .....	3-13
Frequency .....	1-9	Receiving the Data Message .....	3-13
DC Level .....	1-9	Local Lockout and Clear	
Signal Impurities .....	1-9	Lockout/Set Local Messages .....	3-13
Distortion .....	1-9	Clear Message .....	3-14
SINAD .....	1-10	Abort Message .....	3-15
		Status Byte Message .....	3-16
		Require Service Message .....	3-17
		Trigger Message and Clear	
		Key Triggering .....	3-17



**CONTENTS (cont'd)**

	<u>Page</u>		<u>Page</u>
Remote Operation, Hewlett-Packard		DETAILED OPERATING INSTRUCTIONS	3-33
Interface Bus	3-19	AC Level	3-33
HP-IB Compatibility	3-19	Automatic Operation	3-35
Remote Mode	3-19	Common Mode	3-36
Remote Capability	3-19	DC Level	3-39
Local Mode	3-19	Default Conditions and Power-up	
Local Capability	3-19	Sequence	3-40
Remote-to-Local Mode Changes	3-19	Detector Selection	3-41
Addressing	3-19	Display Level in Watts	3-42
Local Lockout	3-21	Distortion	3-43
Data Messages	3-21	Distortion Level	3-45
Receiving the Data Message	3-21	Error Disable	3-47
Listen Only	3-21	Error Message Summary	3-48
Data Input Format	3-22	Filters	3-51
Program Codes	3-22	Float	3-55
Turning Off Functions	3-23	Hold Decimal Point	3-57
Programming Numeric Data	3-23	Hold Settings	3-58
General Numeric Data Input Format	3-23	HP-IB Address	3-59
Triggering Measurements with the		Input Level Range (DC Level)	3-61
Data Message	3-23	Input Level Range (Except DC Level)	3-62
Special Considerations for		Monitor	3-64
Triggered Operation	3-24	Notch Tune	3-67
Reading Data from the Right		Post-Notch Detector Filtering	
or Left Display	3-24	(Except SINAD)	3-68
Program Order Considerations	3-24	Post-Notch Gain	3-69
Sending the Data Message	3-24	Rapid Frequency Count	3-70
Talk Only Mode	3-25	RATIO and LOG/LIN	3-73
Talk Status Only Mode	3-25	Read Display to HP-IB	3-75
Data Output Format	3-25	Service Request Condition	3-76
Data Output Format	3-25	SINAD	3-78
Error Output Format	3-25	Special Functions	3-80
Receiving the Clear Message	3-25	Time Between Measurements	3-86
Receiving the Trigger Message	3-26		
Receiving the Remote Message	3-26	<b>Section 4</b>	
Receiving the Local Message	3-26	<b>PERFORMANCE TESTS</b>	
Receiving the Local		Introduction	4-1
Lockout Message	3-26	Equipment Required	4-1
Receiving the Clear Lockout/Set		Test Record	4-1
Local Message	3-26	Calibration Cycle	4-1
Receiving the Pass Control Message	3-26	Abbreviated Performance Testing	4-1
Sending the Require Service Message	3-26	PERFORMANCE TESTS	4-2
Selecting the Service Request		AC Level Accuracy	4-2
Condition	3-27	DC Level Accuracy	4-9
Sending the Status Byte Message	3-27	Residual Distortion and Noise	4-11
Sending the Status Bit		Distortion and SINAD Accuracy	4-12
Message	3-27	Frequency Accuracy and Sensitivity	4-14
Receiving the Abort Message	3-27	Audio Filters	4-15
HP-IB Syntax and Characteristics		Input Impedance	4-22
Summary	3-29	Common-Mode Rejection Ratio	4-24
		Performance Test Record	4-26

## CONTENTS (cont'd)

	<u>Page</u>		<u>Page</u>
<b>Section 5</b>			
<b>ADJUSTMENTS</b>			
Introduction .....	5-1	Input Flatness .....	5-4
Safety Considerations .....	5-1	Common-Mode Rejection .....	5-8
Equipment Required .....	5-1	Input DC Offset .....	5-9
Factory-Selected Components .....	5-1	400 Hz High-Pass and Weighting	
Post-Repair Tests,		Bandpass Filters .....	5-10
Adjustments, and Checks .....	5-1	Notch Filter Tune and Balance .....	5-12
Related Adjustments .....	5-2	Voltmeter (Using an HP-IB	
ADJUSTMENTS .....	5-3	Controller) .....	5-13
Internal Reference Frequency .....	5-3	Voltmeter (Not Requiring an HP-IB	
		Controller) .....	5-16

## Section 1

# GENERAL INFORMATION

### 1-1. INTRODUCTION

This manual contains information required to install, operate, test, adjust, and service the Hewlett-Packard Model 8903E Distortion Analyzer. This manual documents options installed in the Distortion Analyzer such as rear-panel connections and internal plug-in filters.

This section of the manual describes the instruments documented by the manual and covers instrument description, options, accessories, specifications, and other basic information. This section also contains principles of operation on a simplified block diagram level and basic information on audio measurements. The other sections contain the following information:

**Section 2, Installation:** provides information about initial inspection, preparation for use (including address selection for remote operation), and storage and shipment.

**Section 3, Operation:** provides information about panel features, and includes operating checks, operating instructions for both local and remote operation, and maintenance information.

**Section 4, Performance Tests:** provides the information required to check performance of the instrument against the critical specifications in Table 1-1.

**Section 5, Adjustments:** provides the information required to properly adjust the instrument.

**Section 6, Replaceable Parts:** provides ordering information for all replaceable parts and assemblies.

**Section 7, Instrument Changes:** provides instrument modification, recommendations, and procedures.

**Section 8, Service:** provides the information required to repair the instrument.

Sections 1 through 5 are bound in this volume, the *Operation and Calibration Manual*. Sections 6 through 8 are bound in two separate volumes, the *Service Manual*. The *Service Manual* is comprised of an *HP 8903E Service Supplement*, and an *HP 8903B Service Manual*. Copies of the *Service Manual* are not supplied with the instrument unless specifically requested (as option 915) at time of instrument order. The *Operation and Calibration Manual* is supplied with the instrument order. When option 915 is requested, the complete

service manual (the *HP 8903E Service Supplement* and the *HP 8903B Service Manual*) is supplied with the instrument order.

Copies of all volumes can be ordered through your nearest Hewlett-Packard sales office. The part numbers are listed on the title page of this manual.

Also listed on the title page of this manual, below the manual part number, is a microfiche part number. This number may be used to order 100 × 150 mm (4 × 6 inch) microfilm transparencies of this manual. Each microfiche contains up to 96 photo-duplicates of the manual's pages. The microfiche package also includes the latest MANUAL CHANGES supplements, as well as all pertinent Service Notes.

### 1-2. SPECIFICATIONS

Instrument specifications are listed in Table 1-1. These are the performance standards, or limits against which the instrument may be tested. Characteristics listed under Supplemental Information, Table 1-2, are not warranted specifications but are typical characteristics included as additional information for the user.

### 1-3. SAFETY CONSIDERATIONS

This product is a Safety Class I instrument (that is, provided with a protective earth terminal). The Distortion Analyzer and all related documentation must be reviewed for familiarization with safety markings and instructions before operation. Refer to the *Safety Considerations* page found at the beginning of this manual for a summary of the safety information. Safety information pertinent to the task at hand (installation, performance testing, adjustment, or service) is found throughout the manual.

### 1-4. INSTRUMENTS COVERED BY MANUAL

**Serial Numbers.** This instrument has a two-part serial number in the form 0000A00000 which is stamped on the serial number plate attached to the rear of the instrument. The first four digits and the letter constitute the serial number prefix, and the last five digits form the suffix. The prefix is the same for all identical instruments. It changes only when a change is made to the instrument. The suffix, however, is assigned sequentially and is different for each instrument. The contents of this manual apply directly to instruments having the same serial prefix(es) as listed under SERIAL NUMBERS on the title page.

**Options.** Electrical Option 001, internal plug-in filter options, and various mechanical options are documented in this manual. The differences are noted under the appropriate paragraph such as *Options* in Section 1, the Replaceable Parts List, and the schematic diagrams.

## 1-5. MANUAL CHANGES SUPPLEMENT

An instrument manufactured after the printing of this manual may have a serial prefix that is not listed on the title page. An unlisted serial prefix indicates that the instrument differs in some way from those documented in this manual.

A "Manual Changes Supplement" is shipped with this manual to provide you with the most current change information available at the time of shipment. In addition to change information the supplement may contain information for correcting errors in the manual.

To keep this manual up to date and as accurate as possible, Hewlett-Packard recommends that you periodically request the latest Manual Changes Supplement. The supplement is identified with the print date and part number that appears on the title page. Complimentary copies of the supplement are available from Hewlett-Packard.

## 1-6. DESCRIPTION

### 1-7. General

The HP Model 8903E Distortion Analyzer is an audio measurement system covering the frequency range of 20 Hz to 100 kHz. The analyzer can perform distortion analysis, frequency count, ac level, dc level, and SINAD measurements. The Distortion Analyzer reduces the number of instruments required in many applications involving audio signal characterization.

The Distortion Analyzer is easy to use. All measurements are selected by one or two keystrokes. For distortion measurements, the Distortion Analyzer automatically ranges to, and tunes to the input signal. Measurement and output ranges are automatically selected for optimum resolution and accuracy.

The combined capabilities of the instrument are enhanced by microprocessor control, resulting in more capability than would be available from separate instruments. For example, using the ratio key allows you to set a 0 dB or 100% reference for making frequency response measurements. Microprocessor control allows flexible and versatile display formats.

For example, ac level can be displayed in V, mV, dBm into 600 $\Omega$ , watts, or as a ratio (in % or dB) referenced to an entered or measured value.

Virtually all functions are remotely programmable through the Hewlett-Packard Interface Bus (HP-IB)<sup>1</sup>. Programming is easy and straightforward. All measurements are made through a single input. This eliminates the need to switch between multiple inputs under remote control and reduces software development time and hardware costs. The Distortion Analyzer measures the true rms level on all ac measurements. True rms measurements assure greater accuracy when measuring complex waveforms and noise. For those applications where average detection is required, the analyzer can be switched to average responding (rms calibrated) detection via a front-panel key. Accurate distortion measurements typically can be made to less than 0.003% (-90 dB) between 20 Hz and 20 kHz.

### 1-8. Audio Testing

The Distortion Analyzer has numerous features which make audio testing simple and convenient. For example, distortion results can be displayed in % or dB. AC level measurements can be displayed in volts, dBm into 600 $\Omega$ , or watts. Measurement results can be displayed in % or dB relative to a measured or entered value. Finding the 3 dB points of filters and amplifiers is simplified by using the relative display feature. The Distortion Analyzer also features high accuracy. The internal Voltmeter flatness is better than 0.5% (0.05 dB) over the range of 20 Hz to 20 kHz. Residual Distortion is typically 0.003% (-90 dB) over the same range. See Figure 1-1.

**Balanced Input.** The Distortion Analyzer has a selectable balanced input configuration for testing balanced devices. For example, in the quest for higher output power, many audio amplifiers use bridged output stages. Such amplifiers can be difficult to characterize because their outputs cannot be grounded. To test these devices, the usual approach has been to use a balanced, calibrated isolation transformer connected to an analyzer with an unbalanced input. The balanced input on the Distortion Analyzer makes transformers unnecessary. With the analyzer input in the float position, connect the bridged device directly to the Distortion Analyzer to make measurements.

<sup>1</sup>  HP-IB: Not just IEEE-488, but the hardware, documentation and support that delivers the shortest path to a measurement system.

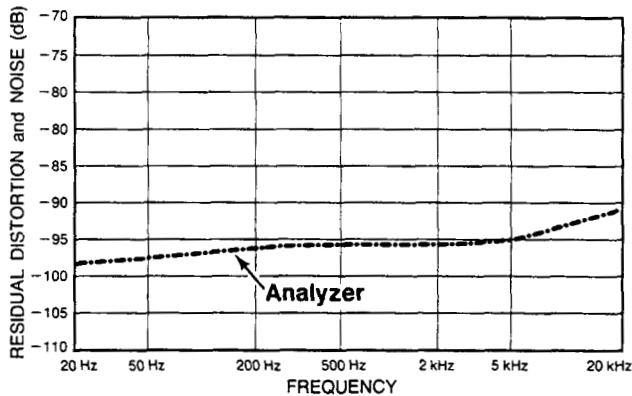

Figure 1-1. Typical Analyzer Residual Distortion

### 1-9. Transceiver Testing

The Distortion Analyzer has several measurements and features specifically designed for transceiver testing. It has SINAD measurements for receiver testing, optional internal plug-in weighting filters for testing to international standards, a reciprocal counter for measuring squelch tones, and an optional internal plug-in 400 Hz high-pass filter for eliminating squelch tones when measuring transmitter audio distortion.

SINAD is one of the most basic receiver measurements. It must be made repeatedly when performing sensitivity or adjacent-channel sensitivity tests. In the Distortion Analyzer, the SINAD measurement is more heavily filtered than the distortion measurement in order to smooth the noisy signals encountered in receiver testing. The filtering is optimized for excellent repeatability and speed (2 readings/second typical). Some automatic distortion analyzers have a tendency to become untuned when measuring SINAD on noisy signals. The Distortion Analyzer overcomes this problem by providing a front panel key which locks the notch filter at the input frequency. For SINAD ratios less than 25 dB, a Special Function can be used to round the digital display to the nearest 0.5 dB to reduce digit flicker.

For accurate noise ratio measurements, the Distortion Analyzer uses true rms detection for SINAD. Most older instruments employ average detection which reads low for noise. The discrepancy can be 1.5 dB or greater and varies with the ratio being measured. For correlating results with past test data, the Distortion Analyzer's detector can be switched via a front-panel key to an average responding configuration.

For transceivers, the Distortion Analyzer has an optional, internal plug-in seven-pole 400 Hz high-pass filter for rejecting squelch tones. Rejection of squelch

tones up to 250 Hz is greater than 40 dB. Therefore, audio distortion measurements to 1% residual distortion can be made without disabling the transmitter squelch tones.

Under remote control, the Distortion Analyzer can count burst tone sequences. Typically the maximum count rate is 8 ms/reading.

### 1-10. Systems

The Distortion Analyzer features capabilities for general systems applications. The distortion measurements are fully automatic, programmable, and fast. The typical time to tune and return the first distortion measurement is 1.5 seconds with a measurement rate of 2 readings/second thereafter. The residual distortion of the analyzer is typically 0.003% (-90 dB) between 20 Hz and 20 kHz.

Often, systems applications involve measuring low level ac signals. The Distortion Analyzer features a full range ac level display of 0.3000 mV with an accuracy of 4% of reading (2% of reading for levels >50 mV and from 20 Hz to 20 kHz). The ac detector is switchable between true rms and average responding detection. The 3 dB measurement bandwidth for both detectors is greater than 500 kHz.

Since many systems have noise problems, the Distortion Analyzer has both 30 and 80 kHz low-pass filters to reject high frequency noise. In addition, the optional internal plug-in 400 Hz high-pass filter attenuates line-related hum and noise by more than 68 dB.

A special binary programming mode is available in remote operation. The rapid frequency count mode provides a packed, four-byte output for fast counting over HP-IB.

### 1-11. OPTIONS

#### 1-12. Electrical Options

**Electrical Option 001.** This option provides a rear-panel (instead of front-panel) connection for the INPUT and MONITOR connectors.

**Internal Plug-in Filter Options.** The Distortion Analyzer has two internal plug-in filter positions; each position can be loaded with any one of six optional filters. Each filter is referenced to its corresponding filter position by one of two option numbers. For example, the 400 Hz High-Pass Filter Option can be ordered as Option 010 which corresponds to the left-most filter position, or as Option 050 which corresponds to the right-most filter position. These optional plug-in filters can be configured in any combination desired. If there is no filter ordered for a position, a jumper wire is loaded and a label marked

"No Filter" is placed above the filter key on the front panel. The following list includes the name and option numbers for each available filter.

400 Hz High-Pass Filter (Option 010, 050).  
 CCITT Weighting Filter (Option 011, 051).  
 CCIR Weighting Filter (Option 012, 052).  
 C-MESSAGE Weighting Filter (Option 013, 053).  
 CCIR/ARM Weighting Filter (Option 014, 054).  
 "A" Weighting Filter (Option 015, 055).

Specific information on each plug-in filter option can be found in the Detailed Operating Instructions in Section 3 under "Filters".

### 1-13. Mechanical Options

The following options may have been ordered and received with the Distortion Analyzer. If they were not ordered with the original shipment and are now desired, they can be ordered from the nearest Hewlett-Packard office using the part number included in each of the following paragraphs. The mechanical options are shown in Figure 1-2.

**Front Handle Kit (Option 907).** Ease of handling is increased with the front-panel handles. Order HP part number 5061-9689.

**Rack Flange Kit (Option 908).** The Distortion Analyzer can be solidly mounted to the instrument rack using the flange kit. Order HP part number 5061-9677.

**Rack Flange and Front Handle Combination Kit (Option 909).** This is not a front handle kit and a rack flange kit packaged together; it is composed of a unique part which combines both functions. Order HP part number 5061-9683.

### 1-14. HEWLETT-PACKARD INTERFACE BUS (HP-IB)

#### 1-15. Compatibility

The Distortion Analyzer is compatible with HP-IB to the extent indicated by the following code: SH1, AH1, T5, TE0, L3, LE0, SR1, RL1, PP0, DC1, DT1, C0, E1. The Distortion Analyzer interfaces with the bus via open collector TTL circuitry. An explanation of the compatibility code can be found in IEEE Standard 488, "IEEE Standard Digital Interface for Programmable Instrumentation" or the identical ANSI Standard MC1.1. For more detailed information relating to programmable control of

the Distortion Analyzer, refer to Remote Operation, Hewlett-Packard Interface Bus in Section 3 of this manual.

#### 1-16. Selecting the HP-IB Address

The HP-IB address switches are located within the Distortion Analyzer. The switches represent a five-bit binary number. This number represents the talk and listen address characters which an HP-IB controller is capable of generating. In addition, two more switches allow the Distortion Analyzer to be set to talk only or listen only. A table in Section 2 shows all HP-IB talk and listen addresses. Refer to *HP-IB Address Selection* in Section 2 of this manual.

#### 1-17. ACCESSORIES SUPPLIED

The accessories supplied with the Distortion Analyzer are shown in Figure 1-2.

Time delay fuses with a 1.5A rating for 100/120 Vac operation (HP 2110-0059) and a 0.75A rating for 220/240 Vac operation (HP 2110-0018) are supplied. One fuse is installed in the instrument at the time of shipment. The rating of the installed fuse is selected according to the line voltage specified by the customer. If the voltage is not specified, the rating of the installed fuse will be selected according to the country of destination.

For Option 001 only, two type BNC-to-banana-plug adapters (HP 5021-0844) are also supplied for use when double-ended inputs or outputs are desired. The conductor of the banana jack is connected to the center conductor of the BNC adapter connector. These adapters are used when the front-panel INPUT or OUTPUT FLOAT switches are set to FLOAT.

#### 1-18. ELECTRICAL EQUIPMENT AVAILABLE

(Also refer to Service Accessories, Table 1-4.)

#### 1-19. HP-IB Controllers

The Distortion Analyzer has an HP-IB interface and can be used with any HP-IB compatible computing controller or computer for automatic systems applications.

#### 1-20. Front-to-Rear-Panel Connectors Retrofit Kit

This kit contains all the necessary components and full instructions for converting instruments with front-panel connections for INPUT and MONITOR to rear-panel connections. Order HP part number 08903-60177. After installation and calibration, performance will be identical to the HP 8903E Option 001.





**SPARE INTERNAL FUSES**

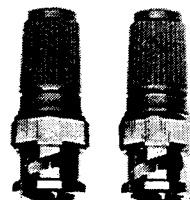

**BNC TO BANANA PLUG ADAPTER**

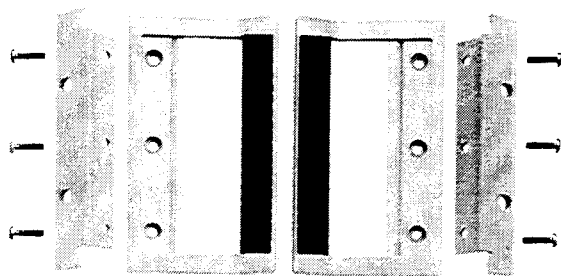

**OPTION 909  
RACK FLANGE AND FRONT  
HANDLE COMBINATION KIT**

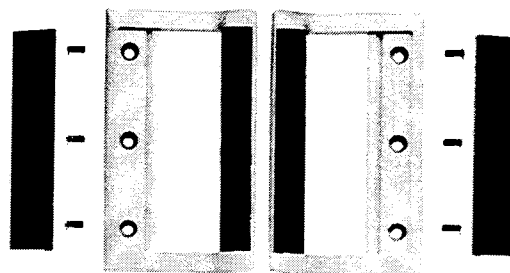

**OPTION 907  
FRONT HANDLE KIT**

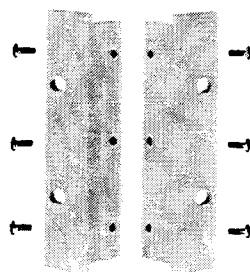

**OPTION 908  
RACK FLANGE KIT**

NOTE: Refer to ACCESSORIES SUPPLIED, for more details.

*Figure 1-2. HP Model 8903E Accessories Supplied, and Options 907, 908, and 909*

**1-21. Rear-to-Front-Panel Connectors Retrofit Kit**

This kit contains all the necessary components and full instructions for converting instruments with rear-panel connections for INPUT and MONITOR to front-panel connections. Order HP part number 08903-60178. After installation and calibration, performance will be identical to the standard HP 8903E.

**1-22. MECHANICAL EQUIPMENT AVAILABLE**

**1-23. Chassis Slide Mount Kit**

This kit is extremely useful when the Distortion Analyzer is rack mounted. Access to internal circuits and components or the rear-panel is possible without removing the instrument from the rack. Order HP part number 1494-0060 for 431.8 mm (17 in.) fixed slides, and part number 1494-0061 for the correct adapters for non-HP rack enclosures.

**1-24. Chassis Tilt Slide Mount Kit**

This kit is the same as the Chassis Slide Mount Kit above except it also allows the tilting of the instrument up or down 90°. Order HP part number 1494-0062 for 431.8 mm (17 in.) tilting slides, and part number 1494-0061 for the correct adapters for non-HP rack enclosures.

**1-25. RECOMMENDED TEST EQUIPMENT**

Table 1-3 lists the test equipment recommended for use in testing, adjusting, and servicing the Distortion Analyzer. If any of the recommended equipment is unavailable, instruments with equivalent minimum specifications may be substituted. Table 1-3 also includes some alternate equipment listings.

**1-26. PRINCIPLES OF OPERATION FOR SIMPLIFIED BLOCK DIAGRAM**

The HP Model 8903E Distortion Analyzer combines two instruments into one: a general purpose voltmeter with a tunable notch filter at the input, and a frequency counter. Measurements are managed by a microprocessor-based Controller. This combination forms an instrument that can make most common measurements on audio circuits automatically. To add to its versatility, the Distortion Analyzer also has selectable input filters, and HP-IB programmability.

The operation of the instrument is described in the following order: Voltmeter and Notch Filter, Counter, and Controller. Refer to Figure 1-3.

**1-27. Voltmeter and Notch Filter**

The amplitude measurement path flows from the INPUT connector to the MONITOR output (on the front panel) and includes the Input and Output RMS/Average Detectors, dc voltmeter (the Voltage-to-Time Converter and Counter). Measurements are made on

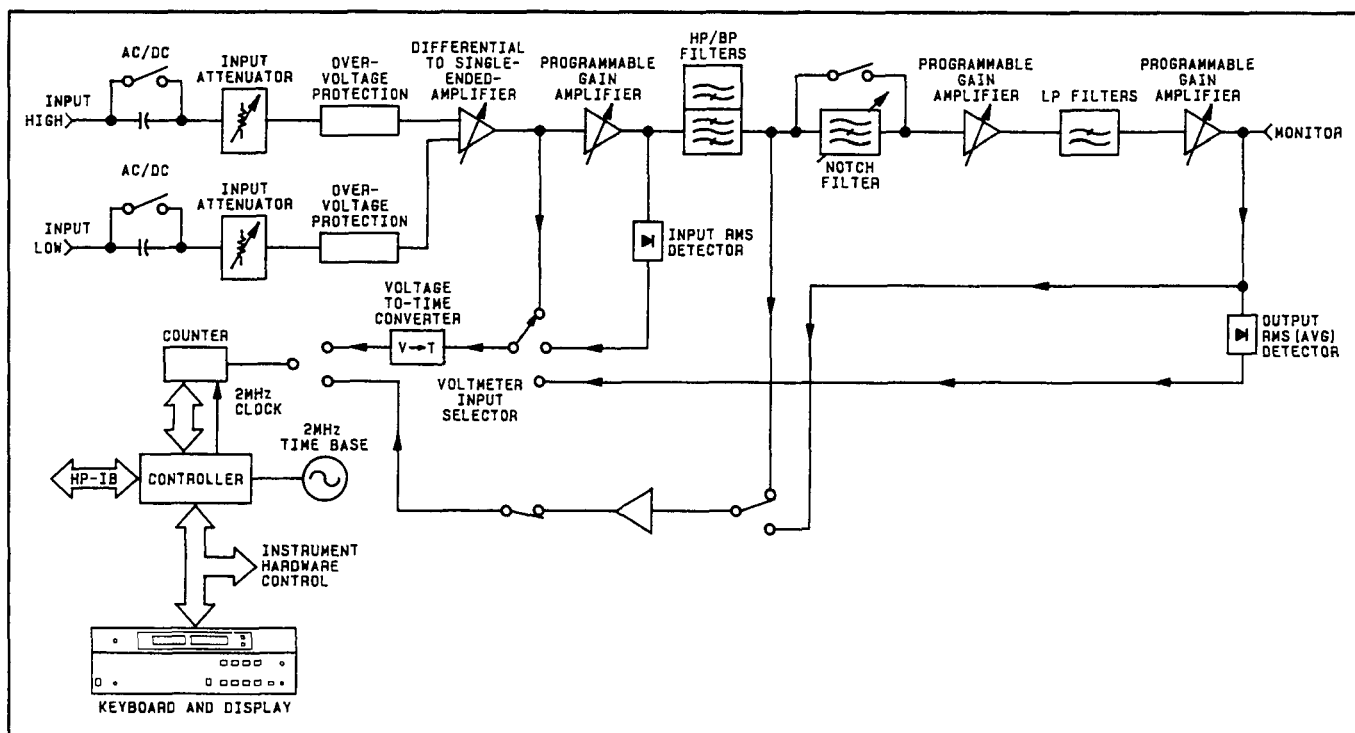

Figure 1-3. Simplified HP 8903E Distortion Analyzer Block Diagram

the difference between the signals on the inner conductor and shield of the INPUT connector or, for option 001, the HIGH and LOW connectors. Combined differential and common-mode levels can be as high as 300V. However, for safety purposes only 42V maximum is allowed on the outer conductor of the single BNC input connector when in the FLOAT position.

The input signal is ac coupled for all measurement modes except dc level. The signal is scaled by the Input Attenuator to a level of 3V or less. To protect the active circuits that follow, the Over-Voltage Protection circuit opens whenever its input exceeds 15V. The differential signal is converted to a single-ended signal (that is, a signal referenced to ground) and amplified. In the dc level mode, the dc voltage is measured at this point by the dc voltmeter. The signal is further amplified by a Programmable Gain Amplifier which is ac coupled. The gain of this amplifier and the Differential-to-Single-Ended Amplifier are programmed to keep the signal level going into the Input Detector and Notch Filter between 1.7 and 3 Vrms. This optimizes the effectiveness and accuracy of the amplifiers, particularly in the distortion and SINAD modes.

The output from the first Programmable Gain Amplifier is converted to dc by the Ranging RMS Detector, and measured by the dc voltmeter. The output of this detector is used to set the gain of the input circuits. The signal then passes through the internal plug-in HP/BP filters to the input RMS/Average detector and becomes the numerator of the SINAD measurement, and the denominator of the distortion measurement (refer to Basics of Audio Measurements). The Input RMS/Average Detector is not used to make the ac level measurement; the Output RMS/Average Detector is used for this measurement. For dc level measurements, the Ranging RMS Detector also monitors the ac component (if there is one) and lowers the gain of the input path if the signal will overload the input amplifiers; otherwise, the gain of the input path is determined by measuring the dc level. At this point, one of the two internal plug-in filters can be inserted into the signal path. The 400 Hz High-Pass Filter is usually used to suppress line hum, or the low frequency squelch tone used on some mobile transceivers. The Weighting Filters have bandpass frequency responses that simulate the "average" response of human hearing. In the SINAD, distortion, and distortion level modes, the frequency of the input signal is counted at the output of the internal plug-in HP/BP Filters.

When measuring SINAD, distortion, or distortion level, the fundamental of the signal is removed by the Notch Filter. The output from the filter is the distortion and noise of the signal. In the ac level mode, the Notch Filter is bypassed. After amplifying and low-pass filtering, the output from the Notch Filter is converted to dc by the Output RMS/Average Detector, and measured by the dc voltmeter.

When measuring distortion, distortion level, or SINAD, the Notch Filter is automatically tuned to the frequency counted at the input to the filter. Coarse tuning is via the Controller. Fine tuning and balance are via circuitry internal to the Notch Filter. In SINAD mode, a front-panel key allows you to lock the notch at a given input frequency, so that the notch will not become untuned in the presence of noise. The two Programmable Gain Amplifiers, following the Notch Filter, amplify the low-level noise and distortion signals from the Notch Filter. The overall gain of the two amplifiers is normally set to maintain a signal level of 0.3 to 3V at the MONTIOR output.

The 30 kHz and 80 kHz LP Filters are selected from the Keyboard. With no low-pass filtering, the 3 dB bandwidth of the measurement system is approximately 750 kHz. The filters are most often used to remove the high-frequency noise components in low-frequency SINAD and distortion measurements. The output from the second Programmable Gain Amplifier drives the front-panel MONITOR output connector. The frequency of this signal is also measured by the Counter in the ac level mode because of the increased sensitivity at this point.

The Output Detector is read by the dc voltmeter in the ac level, SINAD (the denominator), distortion (the numerator), and distortion level modes. It is also used to set the gain of the two Programmable Gain Amplifiers. Both the input and output detectors can be configured via front-panel keys to respond to the absolute average of the signal instead of the true rms value. The Voltage-to-Time Converter converts the dc inputs into a time interval which is measured by the Counter.

## 1-28. Counter

The Counter is a reciprocal counter. To measure frequency, it counts the period of one or more cycles of the signal at its input, then the Controller divides the number of periods by the accumulated count. The reference for the Counter is the 2 MHz Time Base which also is the clock for the Controller. The Counter has three inputs and two modes of operation:

**Voltage Measurement.** The time interval from the Voltage-to-Time Converter is counted. The accumulated count is proportional to the dc voltage. For direct measurements (ac level, dc level, and distortion level), the count is processed directly by the Controller and displayed on the right display. For ratio measurements (SINAD and distortion), the counts of two successive measurements are processed and displayed. For SINAD and distortion, the ratio of the outputs of the Input and Output RMS/Average Detectors is computed.

**Input Frequency Measurement.** The signal from the last Programmable Gain Amplifier or the internal plug-in HP/BP Filters is conditioned by the Counter Input Schmitt Trigger to make it compatible with the Counter's input. The period of the signal is then counted, the count is processed by the Controller, and the frequency is displayed on the left display.

### 1-29. Controller

The entire operation of the instrument is under control of a microprocessor-based Controller. The Controller sets up the instrument at turn-on, interprets Keyboard entries, executes changes in mode of operation, continually monitors instrument operation, sends measurement results and error messages to the front-panel displays, and interfaces with HP-IB. In addition, its computing capability is used to simplify circuit operation. For example, it forms the last stage of the Counter, converts measurement results into ratios (in % or dB), etc. It also contains routines useful for servicing the instrument.

### 1-30. BASICS OF AUDIO MEASUREMENTS

The "audio" frequency range is usually taken to be from 20 Hz to 20 kHz. Few people have hearing that good, but the term is a convenient one to describe sub-RF frequencies encountered in electronics. The frequency range of the Distortion Analyzer extends beyond the audio range to include fundamentals up to 100 kHz.

Electronic instrumentation provides most of the tools for quantitative analysis of audio signals. Thus, if the signal is non-electrical (for example, mechanical or acoustic), it must be converted to an electrical signal by a transducer of some kind (for example, strain gauge or microphone) before it can be analyzed. Apart from attentive listening to a hi-fi system, the most intuitive way of analyzing an electrical signal in the audio range is visually with an oscilloscope. Here you get a feeling for the signal's size (loudness), frequency (pitch), and shape (timbre). You can also determine if these parameters change with time or

are stable, and you can even make some quantitative measurements on it (for example, peak level, dc offset, period, risetime, etc.) Many times, however, the parameter sought does not lend itself to easy visual analysis. Thus, the Distortion Analyzer was designed. It combines into one instrument a series of general and specialized instruments, under microprocessor control, that make it easy for you to obtain accurate, quantitative measurements on audio signals of any general waveshape.

### 1-31. AC Level

Consider the very common measurement of a signal's ac rms level. To make this measurement with an oscilloscope, you must first decide the nature of the signal, because from it, the relationship of the peak level to the rms level can be mathematically determined. If the signal is sinusoidal, for example, the rms value is the peak amplitude divided by  $\sqrt{2}$ .

This measurement is greatly simplified with an rms voltmeter which electronically measures the rms level and displays the result. However, no other information about the signal is provided. The Distortion Analyzer contains both an rms and an average responding voltmeter. The rms level of the signal is displayed whenever the AC Level mode is selected. The average level can be displayed by pressing the AVG/RMS key. (When the LED is lit, the analyzer is in Average mode.) A special function is also provided which converts the measurement result into watts for a specified (external) load resistance (accessible only through HP-IB).

Another important ac signal characteristic is the variation in level vs. frequency (flatness). Of course you can easily set a reference level (such as 1V) at a particular frequency (such as 1 kHz) and monitor the change in level as the input frequency is changed. (The external source's level is assumed to be flat; otherwise, it too must be checked.) The Distortion Analyzer makes this measurement easier in two ways. First, the reference can be set to 100% or 0 dB by the press of a button (the RATIO key). Second, the results can be logged into a controller over HP-IB to be plotted on a printer or plotter.

An additional parameter related to ac level is gain, and more often, gain vs. frequency. To make a gain measurement, measure the input to the device, then the output, and take the ratio. You first set an external source as desired, then either measure it or set it as a reference (press RATIO). Then measure the output. The result can be expressed in either % or dB. If desired, an external source can be swept and the gain plotted as a function of frequency.

### 1-32. Frequency

Another common and basic measurement is frequency. With an oscilloscope, you simply determine the time interval between like points on the repetitive waveform and take the reciprocal. With a frequency counter, frequency is measured electronically and displayed. The measurement is easier and usually much more accurate than could be made visually with an oscilloscope.

The Distortion Analyzer contains a counter which displays the frequency of the input signal for all ac measurements. It should be noted that the counter is a reciprocal type; it measures the period of the signal (as you do with an oscilloscope) and computes the reciprocal to obtain the frequency. The advantage of this technique is that for low (audio) frequencies, higher resolution is obtained in a shorter measurement time.

### 1-33. DC Level

Although not part of an audio signal, dc level is a quantity often encountered in audio equipment (for example, bias voltages and outputs from ac-to-dc converters). Sometimes plots of dc level vs. frequency are desired (as in the case of an ac-to-dc converter). The Distortion Analyzer has dc level as one of its measurement modes.

### 1-34. Signal Impurities

Distortion and SINAD are used to describe the impurity content of a signal. These terms are somewhat related and can often be confused. A pure signal is defined as a perfect sinusoid, that is, one whose frequency spectrum contains only a single spectral component. Impurities are not always undesirable. Impurities, for example, are what add character to the sound of musical instruments. Pure signals in music sound monotonous.

However, when testing a linear audio system, if a pure signal is applied to the input, anything but a pure signal at the output indicates that the system is degrading the signal. There are several common classifications of impurities: harmonic distortion (harmonics of the fundamental), intermodulation distortion (beat signals of two or more non-related signals), noise (random signals), and spurious signals (for example, line hum and interference). All but intermodulation distortion are easily measured by the Distortion Analyzer.

### 1-35. Distortion

Harmonic distortion on a spectrally pure signal is created by non-linearities in the circuit through which

it passes. The non-linearities can arise in the transfer characteristics of the active devices or by running the active device into saturation or cutoff. Often, distortion can be reduced by reducing the signal level, filtering, or adding negative feedback.

According to Fourier mathematics, the non-linear terms in the circuit's transfer function give rise to harmonics of the signal. Total harmonic distortion (THD) is usually defined as the ratio of the rms sum of the harmonics to the rms level of the fundamental. The ratio is usually converted to % or dB.

An oscilloscope gives only a rough indication of the amount of distortion present on a signal. A general rule of thumb is that if the non-linearity causing the distortion is "gentle" (for example, not clipped), a trained eye can discern distortion as low as 5% on an oscilloscope display. Figure 1-4 shows several examples of waveforms with 5% THD and the components that combined to produce them (5% distortion would be considered quite high in a quality hi-fi amplifier).

An audio spectrum analyzer, which allows the user to see the magnitude of all harmonics, is perhaps the best instrument to measure harmonic distortion. The audio spectrum analyzer method, however, requires a fairly expensive instrument and some mathematical manipulation.

The traditional method of measuring distortion (accepted by the Institute of High Fidelity<sup>2</sup> and others) is with a distortion analyzer. The method is simple and adequate for most situations. With a distortion analyzer, you simply measure the signal level and set it up as a reference, then you insert a notch filter, tuned to the frequency of the fundamental, and measure the output of the filter relative to the input. This is the method used by the Distortion Analyzer in the DISTN mode where the tuning and measuring are done automatically. When using the distortion analyzer method, it is important to understand that the measurement result is not "total harmonic distortion" as defined above except under the condition that the distortion is not too excessive but that it does predominate over any other signal impurities. Some examples will illustrate these restrictions.

Consider the case of excessive harmonic distortion. Let us use the example of a signal with 10% actual total harmonic distortion in which all the distortion comes from the second harmonic. The second harmonic is then 20 dB below the fundamental as viewed

<sup>2</sup>The Institute of High Fidelity, Inc., Standard Methods Of Measurement For Audio Amplifiers, The Institute of High Fidelity, Inc., New York (1978), p. 9.

on a spectrum analyzer. When this signal is measured by a distortion analyzer, an error results from the first part of the measurement (measuring the input level) because the input level is not quite the same as the level of the fundamental. If the fundamental level were 1 V<sub>rms</sub>, the second harmonic level would be 0.1 V<sub>rms</sub> (one-tenth of the fundamental). The total input level (measured with a true rms voltmeter) is the rms sum of the two components, namely,

$$\text{Input} = \sqrt{(1)^2 + (0.1)^2} = 1.005\text{V}$$

or 0.5% high. Thus, the measurement result would be 9.95% distortion instead of the true 10%. Actually, you can see that the distortion must really be excessive to affect the measurement significantly.

Now consider the case where other types of impurities are significant. Suppose the actual total harmonic distortion is 1% but that there is an additional hum component that has a level that is 1% of the fundamental level. The distortion measured by a distortion analyzer will be 1.4% (that is, 40% or 3 dB high). How, then, can you be sure that the result is a valid measurement of distortion? One way is to observe the MONITOR output with an oscilloscope. If the waveform is clean and harmonically related to the fundamental, the measurement is actual total harmonic distortion. If it is not, selectable filters are provided to remove unwanted signals. Use the optional 400 Hz High-Pass Filter to remove line hum. Use the 30 kHz or 80 kHz Low Pass Filter to remove out-of-band noise. However, select only filters that do not affect the fundamental and the harmonics of interest. Sometimes it is desired to include hum and noise as part of the "distortion" measurement. For

this reason, the measurement is often referred to as a THD+N (total harmonic distortion plus noise) measurement.

### 1-36. SINAD

For most practical purposes the SINAD measurement, as made by the Distortion Analyzer, is equal to the reciprocal of the distortion measurement. It is usually expressed in dB. The notch filter is coarsely programmed to the input frequency by the microprocessor (but fine tuned to the signal at its input). When measuring SINAD in the presence of large amounts of impurities, a front-panel key locks the coarse tuning of the notch filter at the correct input frequency.

SINAD is an acronym for Signal, Noise, And Distortion. The ratio (normally expressed in dB) computed in the SINAD measurement is

$$\text{SINAD} = 20 \log \left( \frac{\text{rms value of signal, noise and distortion}}{\text{rms value of noise and distortion}} \right)$$

The equation eliminates the two restrictions discussed in connection with the distortion measurement.

SINAD is used most often in determining the sensitivity of a receiver. Receiver sensitivity is defined as the RF level that, when modulated in a specified manner with a pure audio tone, creates a certain SINAD (usually 10 or 12 dB) at the receiver's audio output. (The tone can just be discerned in the noise.) Sometimes a noise weighting filter is required in the receiver sensitivity measurement. Optional plug-in Weighting Filters modify the frequency response of the Distortion Analyzer with a bandpass characteristic that approximates the response of human hearing. Weighting Filters which meet most international standards are available.

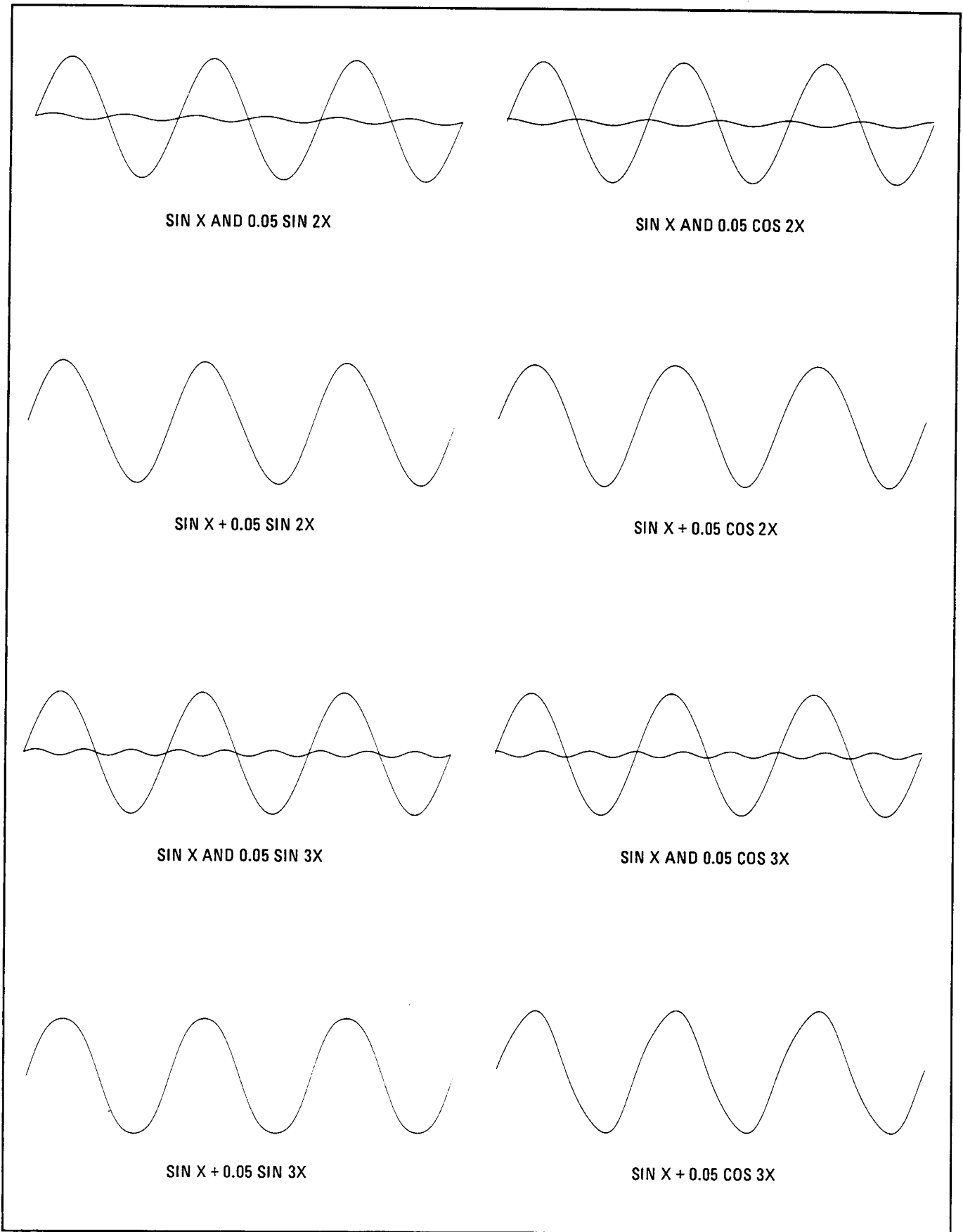

Figure 1-4. Several Waveforms Each With 5% THD and the Signal Components Which Produced Them

Table 1-1. Specifications (1 of 4)

All parameters describe performance in automatic operation or with properly set manual controls with a 1/2-hour warmup period.		
MEASUREMENT		
Characteristic	Performance Limits	Conditions
<b>SINAD</b>		
Fundamental		
Frequency Range	20 Hz to 100 kHz	
Display Range	0 to 99.99 dB	
Accuracy	±1 dB ±2 dB	20 Hz to 20 kHz (unfiltered or with low-pass filters) 20 kHz to 100 kHz
Input Voltage Range	50 mV to 300V	
Residual Noise and Distortion (the higher of)	-80 dB or 15 µV -70 dB or 45 µV -65 dB or 45 µV	20 Hz to 20 kHz; 80 kHz BW 20 Hz to 50 kHz; 500 kHz BW 50 kHz to 100 kHz; 500 kHz BW
<b>DISTORTION</b>		
Fundamental		
Frequency Range	20 Hz to 100 kHz	
Display Range	0.001% to 100% (-99.99 to 0 dB)	
Accuracy	±1 dB ±2 dB	20 Hz to 20 kHz (unfiltered or with low-pass filters) 20 kHz to 100 kHz
Input Voltage Range	50 mV to 300V	
Residual Noise and Distortion (the higher of)	-80 dB or 15 µV -70 dB or 45 µV -65 dB or 45 µV	20 Hz to 20 kHz; 80 kHz BW 20 kHz to 50 kHz; 500 kHz BW 50 kHz to 100 kHz; 500 kHz BW
<b>AC LEVEL</b>		
Full Range Display	300.0V, 30.00V, 3.000V, .3000V, 30.00 mV, 3.000 mV, .3000 mV	
Overrange	33%	Except on the 300.0V range
Accuracy	±2% ±4% ±4%	50 mV to 300V; 20 Hz to 20 kHz 50 mV to 300V; 20 kHz to 100 kHz 0.3 mV to 50mV; 20 Hz to 100 kHz
<b>DC LEVEL</b>		
Full Range Display	300.0V, 48.00V, 16.00V, 4.00V	
Overrange	33%	Except on the 300.0V range
Accuracy	±1.0% of reading ±6 mV	600 mV to 300V Vin <600 mV



Table 1-1. Specifications (2 of 4)

MEASUREMENT (Cont'd)		
Characteristic	Performance Limits	Conditions
<b>FREQUENCY</b>		
Measurement Range	20 Hz to 150 kHz 20 Hz to 100 kHz	In ac level mode In distortion and SINAD modes
Resolution	5 digits 0.01 Hz	Frequencies >100 Hz Frequencies <100 Hz
Accuracy	±(0.004% +1 digit)	
Sensitivity	50 mV 5.0 mV	Distortion and SINAD modes only In ac level mode only
<b>STANDARD AUDIO FILTERS</b>		
<b>30 kHz Low-pass Filter</b>		
3 dB Cutoff		
Frequency	30 ±2 kHz	
Rolloff	3rd order response, 18 dB/octave or 60 dB/decade	
<b>80 kHz Low-pass Filter</b>		
3 dB Cutoff		
Frequency	80 ±4 kHz	
Rolloff	3rd order response, 18 dB/octave or 60 dB/decade	
<b>PLUG-IN AUDIO FILTERS</b>		
<b>400 Hz Highpass Filter</b>		
3 dB Cutoff Frequency	400 ±40 Hz	
Rolloff	7th order response: 42 dB/octave or 140 dB/decade	
<b>CCITT Weighting Filter</b>		
Deviation from Ideal Response:	±0.2 dB ±1 dB ±2 dB ±3 dB	CCITT Recommendation P53 20 to 55°C, 80% relative humidity At 800 Hz 300 Hz to 3 kHz 50 Hz to 3.5 kHz 3.5 kHz to 5 kHz
<b>CCIR Weighting Filter</b>		
Deviation from Ideal Response:	+0.1 dB +0.2 dB ±0.4 dB ±0.5 dB ±1.0 dB ±2.0 dB	CCIR Recommendation 468-2, DIN 45405 20 to 55°C, 80% relative humidity At 6.3 kHz 6.3 kHz to 7.1 kHz 7.1 kHz to 10 kHz 200 Hz to 6.3 kHz 31.5 Hz to 200 Hz, 10 kHz to 20 kHz 20 kHz to 31.5 kHz

Table 1-1. Specifications (3 of 4)

MEASUREMENT (Cont'd)		
Characteristic	Performance Limits	Conditions
<b>PLUG-IN AUDIO FILTERS (Cont'd)</b>		
<b>C-MESSAGE Weighting Filter</b>		Per BSTM 41004
Deviation from Ideal Response:	$\pm 0.1$ dB	20 to 55°C, 80% relative humidity
	$\pm 1.0$ dB	At 1 kHz
		60 Hz to 5 kHz
<b>CCIR/ARM Weighting Filter</b>		CCIR Recommendation 486-2, averaging responding meter, Dolby Labs bulletin No. 19/4.
Deviation from Ideal Response:	$\pm 0.1$ dB	20 to 55°C, 80% relative humidity
	$\pm 0.2$ dB	At 6.3 kHz
	$\pm 0.4$ dB	6.3 kHz to 7.1 kHz
	$\pm 0.5$ dB	7.1 kHz to 10 kHz
	$\pm 1.0$ dB	200 Hz to 6.3 kHz
	$\pm 2.0$ dB	31.5 Hz to 200 Hz, 10 kHz to 20 kHz
		20 kHz to 31.5 kHz
<b>"A"-Weight Filter</b>		IEC Recommendation 179 and ANSI S1.4, type 1 sound level meter
Deviation from Ideal Response:	$\pm 0.1$ dB	20 to 55°C, 80% relative humidity
	$\pm 0.5$ dB	At 1 kHz
	$\pm 1.0$ dB	20 Hz to 10 kHz
		10 kHz to 20 kHz
<b>TEMPERATURE</b>		
Operating	0° to 55°C	
Storage	-55° to 75°C	
<b>INPUT TYPE</b>	Balanced	Full differential
<b>MAXIMUM INPUT</b>	42V Peak	Differentially applied, or between high input and ground.
	42V Peak	Between low input and ground.
<b>INPUT IMPEDANCE</b>		
Resistance	100 k $\Omega$ $\pm 1\%$	Except in dc level mode
	101 k $\Omega$ $\pm 1\%$	In dc level mode only
Shunt Capacitance	<300 pF	Each terminal to ground
<b>COMMON MODE REJECTION RATIO</b>	>60 dB	20 Hz to 1 kHz, $V_{IN} < 2V$
	>45 dB	20 Hz to 1 kHz
	>30 dB	20 Hz to 20 kHz
<b>REMOTE OPERATION</b>	HP-IB STD 488-1978 Compatibility Code: SH1, AH1, T5, TE0, L3, LE0 SR1, RL1, PP0, DC1, DT1, C0, E1	The Hewlett-Packard Interface Bus (HP-IB) is Hewlett-Packard Company's implementation of IEEE Std. 488-1978, "Digital Interface for Programmable Instrumentation". All functions except the line switch and the low terminal float/ground switch are remotely controllable.

Table 1-1. Specifications (4 of 4)

GENERAL		
Characteristic	Performance Limits	Conditions
<b>POWER REQUIREMENTS</b> Line Voltage 100, 120, 220, 240 Vac 100, 120 Vac	+5%, -10% +5%, -10%	48 to 66 Hz 48 to 440 Hz
<b>POWER DISSIPATION</b>	100 V·A maximum	
<b>CONDUCTED AND RADIATED INTERFERENCE (EMI)</b>	MIL STD 461B	Conducted and radiated interference is within the requirements of methods CE03 and RE02 of MIL STD 461B and FTZ 526/527.
<b>CONDUCTED AND RADIATED SUSCEPTIBILITY</b>	MIL STD 461B-1980	Conducted and radiated susceptibility meets the requirements of methods CS01, CS02, and RS03 (1 volt/meter) of MIL STD 461B dated 1980.
<b>NET WEIGHT</b>	11.8 kg (26 lb) 15.9 kg (35 lb)	Net Shipping
<b>DIMENSIONS (Full Envelope)</b> Height Width Depth	146 mm (5.75 in.) 425 mm (16.8 in.) 462 mm (18.2 in.)	Note: For ordering cabinet accessories, the module sizes are 5¼H × 1MW × 17D.

Table 1-2 Supplemental Information

All parameters describe performance in automatic operation or with properly set manual controls.	
MEASUREMENT	
<p><b>SINAD</b> Detection true rms or rms calibrated average.</p> <p><b>Resolution:</b> 0.01 dB. For ratios less than 25 dB, Special Function 16.0 will round the display to the nearest half dB to reduce digit flickering with noisy signals.</p> <p><b>Tuning:</b> notch filter is tuned to counted input frequency.</p> <p><b>Time to Return First Measurement:</b> 1.5s typical. <b>Measurement Rate:</b> 2.0 readings/s typical.</p> <p><b>DISTORTION</b> <b>3 dB Measurement Bandwidth:</b> 10 Hz to 500 kHz. Detection: true rms or rms calibrated average. Displayed Resolution: 0.0001% (&lt;0.1% distortion) 0.001% (0.1% to 3% distortion) 0.01% (3% to 30% distortion) 0.1% (&gt;30% distortion) <b>Time to Return First Measurement:</b> 1.5s typical. <b>Measurement Rate:</b> 2 readings/s typical.</p> <p><b>AC LEVEL</b> <b>AC Converter:</b> true rms responding for signals with crest factor of ≤3 or rms calibrated average detection.</p>	<p><b>AC LEVEL (cont'd)</b> <b>3 dB Measurement Bandwidth:</b> &gt;500 kHz. <b>Time to Return First Measurement:</b> &lt;1.5s typical. <b>Measurement Rate:</b> 2.5 readings/s.</p> <p><b>DC LEVEL:</b> <b>Time to Return First Measurement:</b> &lt;1.5s typical. <b>Measurement Rate:</b> 3 reading/s.</p> <p><b>FREQUENCY MEASUREMENT</b> <b>Measurement Rate:</b> same as measurement mode selected. <b>Counting Technique:</b> reciprocal with 2 MHz time base.</p> <p><b>AUDIO FILTERS</b> <b>400 Hz High-Pass Filter Rejection:</b> &gt;40 dB at 240 Hz; &gt;65 dB at 60 Hz.</p> <p><b>Monitor Output</b> Output Impedance: 600Ω. In ac level mode, provides scaled output of measured input signal. In SINAD, distortion, and distortion level modes, provides scaled output of input signal with the fundamental removed.</p>

Table 1-3. Recommended Test Equipment

Instrument Type	Critical Specifications	Suggested Model	Use*
AC Calibrator	Accuracy: 0.5%, 7 mV to 300V, 20 Hz to 100 kHz Flatness: ±0.1%, 20 Hz to 100 kHz, <6V Output Current: 60 mA Frequency Accuracy: ±5%	HP 745A and HP 746A, Datron 4200 or Fluke 5200A and Fluke 5215A	P,A
Audio Synthesizer	Frequency Range: 20 Hz to 500 kHz Frequency Accuracy: ±4ppm Output Range: 3V into 600Ω Output Attenuation Accuracy: ±0.075 dB, to 0.3 mV range	HP 3336C	P,A
Computing Controller	HP-IB compatibility as defined by IEEE Std. 488 and the identical ANSI Std. MC1.1: SH1, AH1, T2, TE0 L2, LE0, SR0, PP0, DC0, DT0, and C1, 2, 3, 4, 5.	HP 9825A/98034A/98213A or HP 85B Opt. 007	C,T
DC Standard	Output Range: 3 mV to 300V Accuracy: ±0.1% ±0.3 mV	HP 740B or Datron 4000 or Fluke 893AR	P
Digital Voltmeter	AC Accuracy: ±0.2% at 6 Vrms and 1 kHz DC Accuracy: +0.2% at 1V	HP 3455A	A,T
Frequency Standard	Frequency: 0.1, 1, 2, 5, or 10 MHz Accuracy: ±1 ppm	House Standard	A
Oscilloscope	Bandwidth: <3 dB down 0 to 10 MHz Sensitivity: 5 mV per division minimum Input Impedance: 1 MΩ Triggering: Internal and External	HP 1740A	C,A,T
Power Supply	Output: to ±15V	HP 6215A	T
Resistor 100kΩ	Accuracy: ±0.1%	HP 0698-7497	P
Signature Analyzer	Because the signatures documented are unique to a given signature analyzer type, no substitution of types is recommended.	HP 5005A	T
Test Oscillator	Frequency: 1 kHz Output: 30 Vpp	HP 3310A	T
True RMS Voltmeter	Type: true rms responding Level Range: 100 mV to 10V Frequency Range: 20 Hz to 500 kHz Accuracy: ±0.2% of range ±0.2% of reading Coupling: ac	HP 3403C	P
*C = Operator's Checks; P = Performance Tests; A = Adjustments; T = Troubleshooting			

Table 1-4. Service Accessories

Accessory	Specifications	Suggested Model
Digital Test/ Extender Board	No substitution recommended	HP 08903-60018
Extender Board	44 contacts (2 × 22), 3 required	HP 08901-60084
Extender Board	30 contacts (2 × 15), 2 required	HP 08901-60085
Foam Pad	Conductive polyurethane foam, 12 × 12 × 0.25 inches (nonmagnetic)	HP 4208-0094

**NOTE**

*The performance tests, adjustments, and troubleshooting procedures are based on the assumption that the recommended test equipment is used. Substituting alternate test equipment may require modification of some procedures.*

## Section 2 INSTALLATION

### 2-1. INTRODUCTION

This section provides the information needed to install the Distortion Analyzer. Included is information pertinent to initial inspection, power requirements, line voltage and fuse selection, power cables, interconnection, mating connectors, operating environment, instrument mounting, storage, and shipment. In addition, this section also contains the procedure for setting the internal HP-IB talk and listen address switches.

### 2-2. INITIAL INSPECTION

#### WARNING

*To avoid hazardous electrical shock, do not perform electrical tests when there are signs of shipping damage to any portion of the outer enclosure (covers, panels, meters).*

Inspect the shipping container for damage. If the shipping container or cushioning material is damaged, it should be kept until the contents of the shipment have been checked for completeness and the instrument has been checked mechanically and electrically. Procedures for checking electrical performance are given in Section 4. If the contents are incomplete, if there is mechanical damage or defect, or if the instrument does not pass the electrical performance test, notify the nearest Hewlett-Packard office. If the shipping container is damaged, or the cushioning material shows signs of stress, notify the carrier as well as the Hewlett-Packard office. Keep the shipping materials for the carrier's inspection.

### 2-3. PREPARATION FOR USE

#### 2-4. Power Requirements

#### WARNING

*To avoid the possibility of hazardous electrical shock, do not operate this instrument at line voltages greater than 126.5 Vac with line frequencies greater than 66 Hz. Leakage currents at these line settings may exceed 3.5 mA.*

The Distortion Analyzer requires a power source of 100, 120, 220, or 240 Vac, +5% to -10%, 48 to 66 Hz single phase or 100, 120 Vac, +5% to -10%, 48 to 440 Hz single phase. Power consumption is 100 VA maximum.

#### WARNING

*This is a Safety Class I product (that is, provided with a protective earth terminal). An uninterruptible safety earth ground must be provided from the mains power source to the product input wiring terminals, power cord, or supplied power cord set. Whenever it is likely that the protection has been impaired, the product must be made inoperative and be secured against any unintended operation.*

*If this instrument is to be energized via an external autotransformer, make sure the autotransformer's common terminal is connected to the earthed pole of the power source.*

### 2-5. Line Voltage and Fuse Selection

#### CAUTION

*BEFORE PLUGGING THIS INSTRUMENT into the Mains (line) voltage, be sure the correct voltage and fuse have been selected.*

Verify that the line voltage selection card and the fuse are matched to the power source. Refer to Figure 2-1, *Line Voltage and Fuse Selection*.

Fuses may be ordered under HP part numbers 2110-0059, 1.5A (250V time delay) for 100/120 Vac operation and 2110-0018, 0.75A (250V, time delay) for 220/240 Vac operation.

### 2-6. Power Cables

#### WARNING

*BEFORE CONNECTING THIS INSTRUMENT, the protective earth terminals of this instrument must be connected to the protective conductor of the (Mains) power cord. The Mains plug shall only be inserted in a socket outlet provided with a protective earth contact. The protective action must not be negated by the use of an extension cord (power cable) without a protective conductor (grounding).*

This instrument is equipped with a three-wire power cable. When connected to an appropriate ac power receptacle, this cable grounds the instrument cabinet. The type of power cable plug shipped with each instrument depends on the country of destination. Refer to Figure 2-2 for the part numbers of the power cables available.

## 2-7. HP-IB Address Selection

### WARNING

*This task should be performed only by service trained persons who are aware of the potential shock hazard of working on an instrument with protective covers removed.*

*To avoid hazardous electrical shock, the line (Mains) power cable should be disconnected before attempting to change the HP-IB address.*

In the Distortion Analyzer, the HP-IB talk and listen addresses are selectable by an internal switch. The

following procedure explains how the switches are to be set. Refer to Table 2-1 for a listing of the talk and listen addresses. The address is factory set for a Talk address of “\” and a listen address of “<”. (In binary, this is 11100; in decimal it is 28.) To change the HP-IB address, the top cover of the Distortion Analyzer must be removed.

- a. Disconnect the line (Mains) power cable.
- b. Remove any HP-IB cables or connectors from the HP-IB connector.
- c. Remove the Distortion Analyzer top cover.
  1. Remove the two plastic feet from the rear of the top cover by removing the panhead Pozidriv screw within each foot.
  2. Unscrew the Pozidriv screw at the center of the rear edge of the top cover. This is a captive screw and will cause the top cover to pull away from the front frame.
  3. Lift off the top cover.

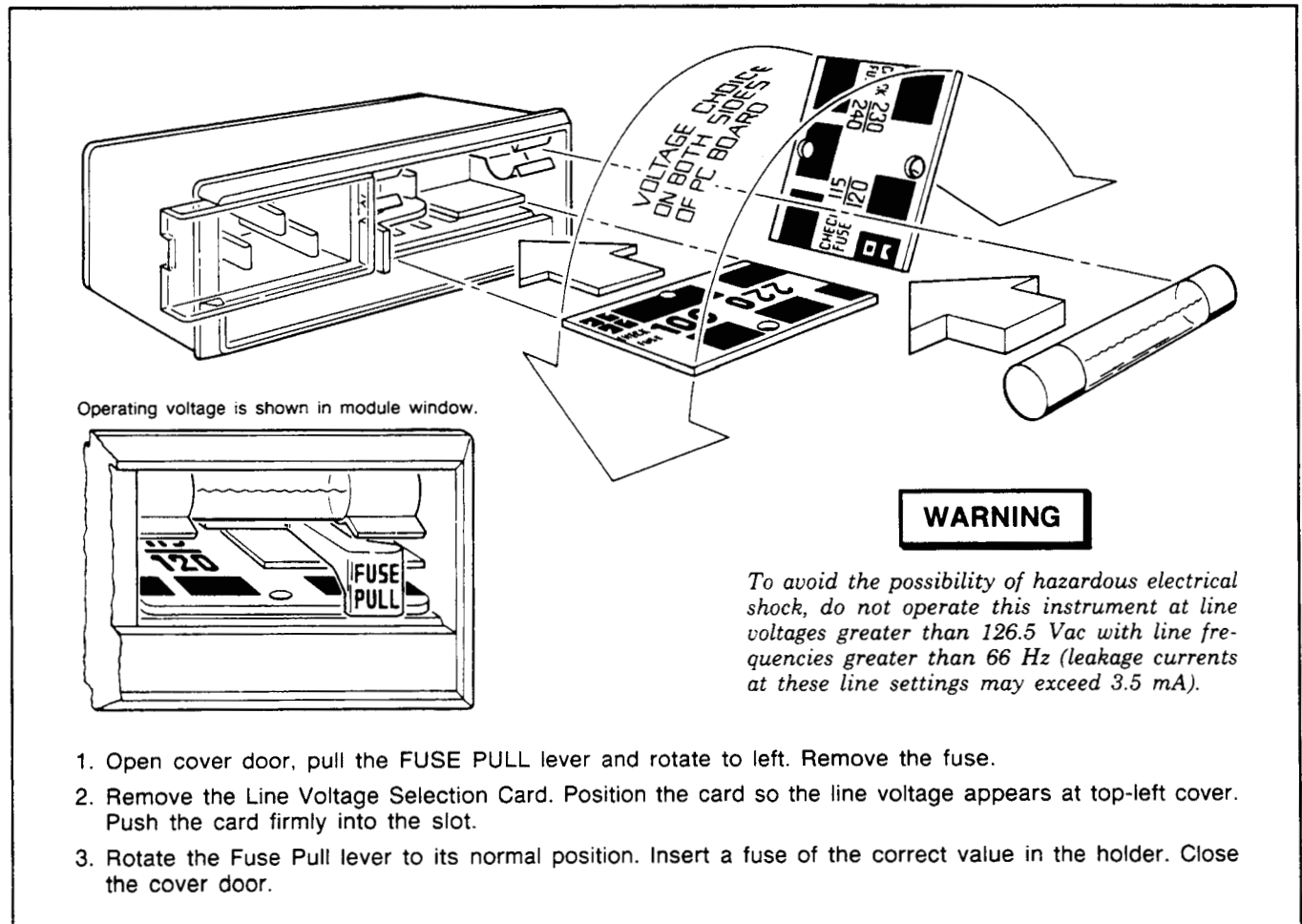
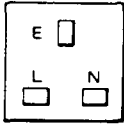
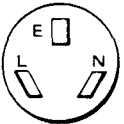
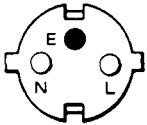
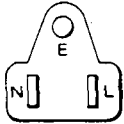
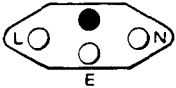
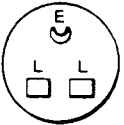
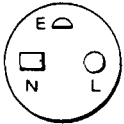
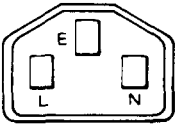

Figure 2-1. Line Voltage and Fuse Selection

Plug Type	Cable HP Part Number	C D	Plug Description	Cable Length (inches)	Cable Color	For Use In Country
<b>250V</b> 	8120-1351 8120-1703	0 6	Straight*BS1363A 90°	90 90	Mint Gray Mint Gray	United Kingdom, Cyprus, Nigeria, Rhodesia, Singapore
<b>250V</b> 	8120-1369 8120-0696	0 4	Straight*NZSS198/ASC112 90°	79 87	Gray Gray	Australia, New Zealand
<b>250V</b> 	8120-1689 8120-1692	7 2	Straight*CEE7-Y11 90°	79 79	Mint Gray Mint Gray	East and West Europe, Saudi Arabia, Egypt, So. Africa, India (unpolarized in many nations)
<b>125V</b> 	8120-1378 8120-1398 8120-1754 8120-1378 8120-1521 8120-1676	5 5 7 1 6 2	Straight*NEMA5-15P 90° Straight*NEMA5-15P Straight*NEMA5-15P 90° Straight*NEMA5-15P	80 80 36 80 80 36	Black Black Black Jade Gray Jade Gray Jade Gray	United States, Canada, Japan (100V or 200V), Mexico, Phillipines, Taiwan
<b>250V</b> 	8120-2104	3	Straight*SEV1011 1959-24507 Type 12	79	Gray	Switzerland
<b>250V</b> 	8120-0698	6	Straight*NEMA6-15P			United States, Canada
<b>220V</b> 	8120-1957 8120-2956	2 3	Straight*DHCK107 90°	79 79	Gray Gray	Denmark
<b>250V</b> 	8120-1860	6	Straight*CEE22-VI (Systems Cabinet use)			

\*Part number shown for plug is industry identifier for plug only. Number shown for cable is HP Part Number for complete cable including plug.  
 E = Earth Ground; L = Line; N = Neutral

Figure 2-2. Power Cable and Mains Plug Part Numbers



- d. Locate the HP-IB address switch accessible through a hole near the center rear of the internal shield cover.
- e. Use a pencil to set the switches to the desired HP-IB address and Talk Only (TON) or Listen Only (LON) condition. The switch is illustrated in Figure 2-3. Facing the board, the left hand switch (marked with a "5") is the most significant address bit (A5 in Table 2-1). Setting a switch toward the printed circuit board places it in its "1" position. If the TON and LON switches are both set to "1", the Talk Only setting will override. If the address switches and the TON switch are all set to "1", the Distortion Analyzer will output one byte (the status byte) each measurement cycle. (Setting all switches to "1" defeats HP-IB operation.)

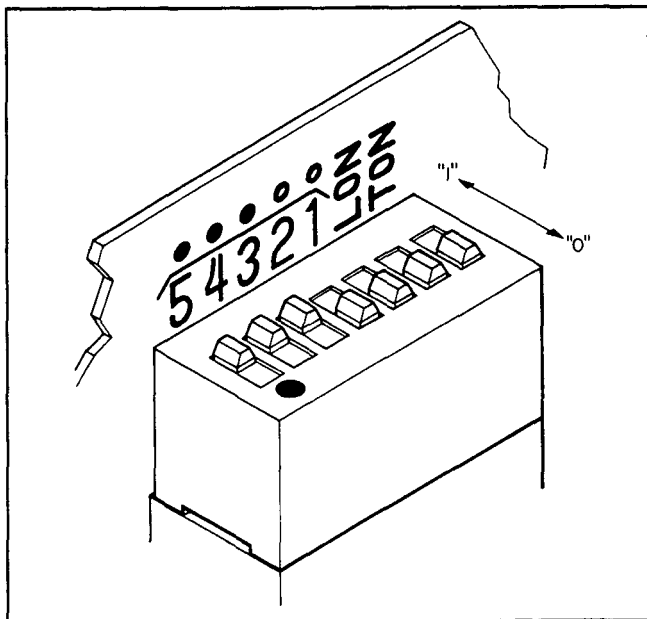

Figure 2-3. The HP-IB Address Switch Shown as Set by the Factory. The Address Shown is 11100 in Binary with Both Talk Only and Listen Only Off.

- f. Reinstall the top cover by reversing the procedure in step c above.
- g. Connect the line (Mains) power cable to the Line Power Module and reconnect the HP-IB cable to the HP-IB connector.
- h. To confirm the setting, refer to HP-IB Address in the *Detailed Operating Instructions* in Section 3 of this manual.

**2-8. Interconnections**

Interconnection data for the Hewlett-Packard Interface Bus is provided in Figure 2-4.

HP-IB Table 2-1. Allowable HP-IB Address Codes

Address Switches					Talk Address Character	Listen Address Character	Decimal Equivalent
A5	A4	A3	A2	A1			
0	0	0	0	0	@	SP	0
0	0	0	0	1	A	!	1
0	0	0	1	0	B	"	2
0	0	0	1	1	C	#	3
0	0	1	0	0	D	\$	4
0	0	1	0	1	E	%	5
0	0	1	1	0	F	&	6
0	0	1	1	1	G	'	7
0	1	0	0	0	H	(	8
0	1	0	0	1	I	)	9
0	1	0	1	0	J	*	10
0	1	0	1	1	K	+	11
0	1	1	0	0	L	,	12
0	1	1	0	1	M	—	13
0	1	1	1	0	N		14
0	1	1	1	1	O	/	15
1	0	0	0	0	P	0	16
1	0	0	0	1	Q	1	17
1	0	0	1	0	R	2	18
1	0	0	1	1	S	3	19
1	0	1	0	0	T	4	20
1	0	1	0	1	U	5	21
1	0	1	1	0	V	6	22
1	0	1	1	1	W	7	23
1	1	0	0	0	X	8	24
1	1	0	0	1	Y	9	25
1	1	0	1	0	Z	:	26
1	1	0	1	1	[	;	27
1	1	1	0	0	\	<	28
1	1	1	0	1	]	=	29
1	1	1	1	0	^	>	30

**2-9. Mating Connectors**

**Interface Connector.** The HP-IB mating connector is shown in Figure 2-4. Note that two securing screws are metric.

**Coaxial Connectors.** Coaxial mating connectors used with the Distortion Analyzer should be the 50Ω BNC male connectors.

**2-10. Operating Environment**

The operating environment should be within the following limitations:

Temperature ..... 0°C to +55°C  
 Humidity ..... <95% relative  
 Altitude ..... <4570 meters (15 000 feet)

Temperature ..... -55°C to +75°C  
 Humidity ..... <95% relative  
 Altitude ..... 15 300 meters (50 000 feet)

**2-11. Bench Operation**

The instrument cabinet has plastic feet and foldaway tilt stands for convenience in bench operation. (The plastic feet are shaped to ensure self-aligning of the instruments when stacked.) The tilt stands raise the front of the instrument for easier viewing of the front panel.

**2-12. Rack Mounting**

**WARNING**

*The Distortion Analyzer is heavy for its size (11.8 kg, 26 lb). Care must be exercised when lifting to avoid personal injury. Use equipment slides when rack mounting.*

**CAUTION**

*DO NOT BLOCK the ventilation holes in the bottom panel. Since this instrument does not use a cooling fan, it is important that good ventilation be provided. Allow for 1 to 2 inches clearance around the bottom panel.*

Rack mounting information is provided with the rack mounting kits. If the kits were not ordered with the instrument as options, they may be ordered through the nearest Hewlett-Packard office. Refer to paragraph 1-13, *Mechanical Options*, in Section 1.

**2-13. STORAGE AND SHIPMENT**

**2-14. Environment**

The instrument should be stored in a clean, dry environment. The following environmental limitations apply to both storage and shipment:

**2-15. Packaging**

**Original Packaging.** Containers and materials identical to those used in factory packaging are available through Hewlett-Packard offices. If the instrument is being returned to Hewlett-Packard for servicing, please fill out one of the blue tags located at the end of this manual. Include on the tag the type of service required, return address, model number, and full serial number and attach it to the instrument. Mark the container "FRAGILE" to assure careful handling. In any correspondence refer to the instrument by model number and full serial number.

**Other Packaging.** The following general instructions should be used for re-packaging with commercially available materials:

- a. Wrap the instrument in heavy paper or plastic. (If shipping to a Hewlett-Packard office or service center, complete one of the blue tags mentioned above and attach it to the instrument.)
- b. Use a strong shipping container. A doublewall carton made of 2.4 MPa (350 psi) test material is adequate.
- c. Use enough shock-absorbing material (75 to 100 mm layer; 3 to 4 inches) around all sides of instrument to provide a firm cushion and prevent movement in the container. Protect the front panel with cardboard.
- d. Seal the shipping container securely.
- e. Mark the shipping container "FRAGILE" to assure careful handling.

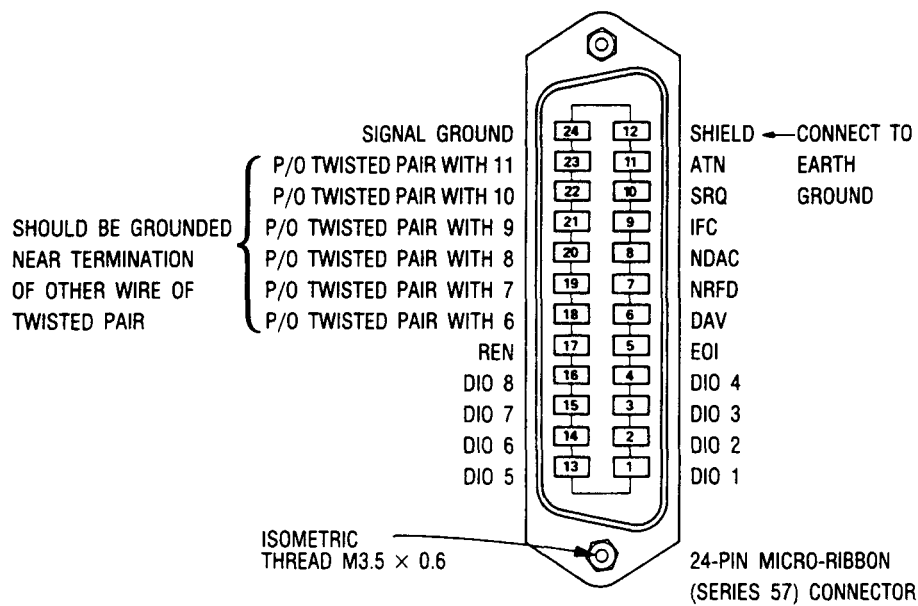

**Logic Levels**

The Hewlett-Packard Interface Bus logic levels are TTL compatible, that is, the true (1) state is 0.0 Vdc to +0.4 Vdc and the false (0) state is 2.5 Vdc to +5 Vdc.

**Programming and Output Data Format**

Refer to Section 3, "Operation".

**Mating Connector**

HP 1251-0293; Amphenol 57-30240.

**Mating Cables Available**

HP 10631A, 1 meter (3.3 ft), HP 10631B, 2 meters (6.6 ft)  
 HP 10631C, 4 meters (13.2 ft), HP 10631D, 0.5 meters (1.6 ft)

**Cabling Restrictions**

1. A Hewlett-Packard Interface Bus system may contain no more than 2 meters (6.6 ft) of connecting cable per instrument.
2. The maximum accumulative length of connecting cable for any Hewlett-Packard Interface Bus system is 20 meters (65.6 ft).

Figure 2-4. Hewlett-Packard Interface Bus Connection

## Section 3 OPERATION

### 3-1. INTRODUCTION

### 3-2. General

This section provides complete operating information for the Distortion Analyzer. Included in this section are descriptions of all front and rear-panel controls, connectors, and indicators, remote and local operator's checks, operating instructions, and operator's maintenance.

### 3-3. Operating Characteristics

Table 3-1 briefly summarizes the major operating characteristics of the Distortion Analyzer. The table is not intended to be an in-depth listing of all operations and ranges but gives an idea of the instrument's capabilities. For more information on the Distortion Analyzer capabilities, refer to the description in Section 1; Table 1-1, *Specifications*; and Table 1-2, *Supplemental Information*. For information on HP-IB capabilities, refer to the summary contained in Table 3-3, *Message Reference Table*.

*In single-ended (FLOAT switch in grounded position) or differential (FLOAT switch in FLOAT position) operation, the input signal voltage is not to exceed 300V when referenced to ground, on the high INPUT connector (inside conductor of the BNC).*

*In differential (FLOAT switch in FLOAT position) operation, the peak voltage on the low INPUT connector (outer conductor of the BNC) is not to exceed 42V.*

#### CAUTION

*Before the Distortion Analyzer is switched on, it must be set to the voltage of the power source, or damage to the instrument may result.*

If the Distortion Analyzer is already plugged in, set the LINE switch to ON. If the power cable is not plugged in, follow these instructions.

1. Check that the line voltage setting matches the power source (see Figure 2-1).
2. Check that the fuse rating is appropriate for the line voltage used (see Figure 2-1). Fuse Ratings are given under paragraph 3-8, *Operator's Maintenance*.
3. Plug in the power cable.
4. Set the LINE switch to ON.

#### NOTE

*When the LINE switch is set to ON, all front-panel indicators will light for approximately 4 seconds after which the instrument is ready to be operated.*

### 3-5. Local Operation

Information covering front-panel operation of the Distortion Analyzer is given in the sections described below. To rapidly learn the operation of the instrument, begin with the Simplified Operation and Operator's Checks. Once familiar with the general operation of the instrument, use the Detailed Operating Instructions for in-depth and complete information on operating the Distortion Analyzer.

### 3-4. Turn-On Procedure

#### WARNING

*Before the Distortion Analyzer is switched on, all protective earth terminals, extension cords, auto-transformers, and devices connected to it should be connected to a protective earth socket. Any interruption of the protective earth grounding will cause a potential shock hazard that could result in personal injury. In addition, verify that a common ground exists between the unit under test and the Distortion Analyzer prior to energizing either unit.*

*For continued protection against fire hazard, replace the line fuse with a 250V time delay fuse of the same rating. Do not use repaired fuses or short-circuited fuseholders.*

*To avoid the possibility of hazardous electrical shock, the input signal voltage on the outer connector (referenced to ground), is not to exceed 42V peak in the FLOAT mode.*

**Simplified Operation.** Information on subsequent pages under *Simplified Operation* provides a quick introduction to front-panel operation of the Distortion Analyzer. It is designed to rapidly orient the novice user with basic procedures and, therefore, is not an exhaustive listing of all Distortion Analyzer functions. However, an index to the Detailed Operating Instructions appears in Table 3-2 to guide the operator to the more complete discussion of the topic of interest.

**Panel Features.** Front-panel controls, indicators, and connectors are illustrated and described in Figure 3-1. This figure describes the functions of the various key groups and summarize briefly how to use them. Rear-panel features are shown in Figure 3-2.

**Detailed Operating Instructions.** The Detailed Operating Instructions provide the complete operating reference for the Distortion Analyzer user. The instructions are organized alphabetically by subtitle. Not only do the instructions contain information on the various measurements that can be made (listed under titles such as AC Level, Distortion, etc.) but there are also individual discussions of nearly all controls, inputs, and outputs, (for example, AVG/RMS Detector, Monitor, etc.). Also included are instructions for using the many User Special Functions (for example, Hold Settings, Error Disable, Special Functions, etc.). The Detailed Operating Instructions are indexed by function in Table 3-2.

Each section contains a general description which covers signal levels, ranges, and other general information. Following the description are related procedures, an operating example, the relevant HP-IB codes, front panel indications, and, where pertinent, a description of the technique the Distortion Analyzer uses to make the measurement. At the end of each discussion are comments intended to guide the user away from measurement pitfalls and to help get the most out of the Distortion Analyzer. Also included are references to other sections which contain related information. The Detailed Operating Instructions are designed so that both casual and sophisticated users can rapidly find at one location all the information needed to apply the instrument to the task at hand.

**Supplemental Information.** In addition to the information described above, several other discussions pertinent to the operating of the Distortion Analyzer to its fullest capabilities are contained in Section 1 of this manual. Principles of Operation for a Simplified Block Diagram is a fundamental description of what the Distortion Analyzer is, and how it works. This information supplements the block diagrams given in the Detailed Operating Instructions and provides a

basis for applying the Distortion Analyzer to various measurement situations. Basics of Audio Measurements is a general discussion of audio measurements. It is intended to provide an intuitive understanding of audio measurements, rather than an in-depth mathematical analysis.

### 3-6. Remote Operation

The Distortion Analyzer is capable of remote operation via the Hewlett-Packard Interface Bus (HP-IB). Instructions pertinent to HP-IB operation cover all considerations and instructions specific to remote operation including capabilities, addressing, input and output formats, the status byte, and service requests. At the end of the discussion is a complete summary of all codes and formats.

In addition to the section described above, information concerning remote operation appears in several other locations. HP-IB Address selection is discussed under paragraph 2-7 in Section 2. Numerous examples of program strings appear throughout the Detailed Operating Instructions described under Local Operation above.

### 3-7. Operator's Checks

Operator's checks are procedures designed to verify the proper operation of the Distortion Analyzer's main functions. Two procedures are provided as described below.

**Basic Functional Checks.** This procedure requires an audio oscillator, oscilloscope, and inter-connecting cables. It assumes that most front-panel controlled functions are being properly executed by the Distortion Analyzer.

**HP-IB Functional Checks.** This series of procedures requires an HP-IB compatible computing controller and an HP-IB interface and connecting cable. The HP-IB Functional Checks assume that front-panel operation has been verified (for example, by performing the Basic Functional Checks). The procedures check all of the applicable bus messages summarized in Table 3-3.

### 3-8. Operator's Maintenance

#### **WARNING**

*For continued protection against fire hazard, replace the line fuse with a 250V time delay fuse of the same rating only. Do not use repaired fuses or short-circuited fuseholders.*

The only maintenance the operator should normally perform is the replacement of the primary power fuse located within the Line Power Module (A14). For instructions on how to change the fuse, refer to Figure 2-1 steps 1 and 3 in Section 2, *Installation*.

Fuses may be ordered by looking up the reference designator F1 in Section 6, *Replaceable Parts*, and ordering the correct part number for 100/120 Vac or for 220/240 Vac operation (both fuses are 250V time delay).

**NOTE**

*If the instrument does not operate properly and is being returned to Hewlett-Packard for service, please complete one of the blue repair tags located at the end of this manual and attach it to the instrument. Refer to paragraph 2-15 in Section 2 for packaging instructions.*

*Table 3-1. Operating Characteristics Summary*

Operating Parameter	Capabilities
<b>Input Limits</b>	Frequency: 20 Hz to 100 kHz (150 kHz, AC Level) Level: $\approx 0$ to 300V ac or dc. Impedance: 100 k $\Omega$ (except DC Level); 101 k $\Omega$ (DC Level); floating input can be selected.
<b>Measurements</b> (including counter frequency measurements except in DC Level)	AC LEVEL: $\approx 0$ to 300 Vac; 20 Hz to 150 kHz. Full range display from .3000 mV to 300.0V in seven ranges. DC LEVEL: 0 to 300 Vdc. Full range display from 4.000V to 300.0V in four ranges. SINAD: 50 mV to 300V; 20 Hz to 100 kHz. Display range 0 to 99.99 dB. DISTN: 50 mV to 300V; 20 Hz to 100 kHz. Display range -99.99 to 0 dB.
<b>Detection</b>	True rms or average detection.
<b>Audio Filters</b>	HP/BP FILTER — Up to two of the following HP/BP filters may be installed: HIGH PASS 400 Hz: 400 $\pm$ 40 Hz (3 dB cutoff) CCITT Weighting: Recommendation P53. CCIR Weighting: CCIR 468-2, DIN 45405 C-MESSAGE: BSTM #41009 FIG 1 A-Weighting: ANSI S1.4, IEC rec 179, DIN 45633 CCIR/ARM Weighting: Dolby Labs  LP FILTER LOW PASS 30 kHz: 30 $\pm$ 2 kHz (3 dB cutoff). 80 kHz: 80 $\pm$ 4 kHz (3 dB cutoff).
<b>Manual Operation</b>	Average and rms detection, notch tune, ratio, log/linear, filter selection and measurement selections can be manually controlled.
<b>Remote Operation</b>	All Distortion Analyzer operations except the LINE and FLOAT switches can be controlled via the Hewlett-Packard Interface Bus.

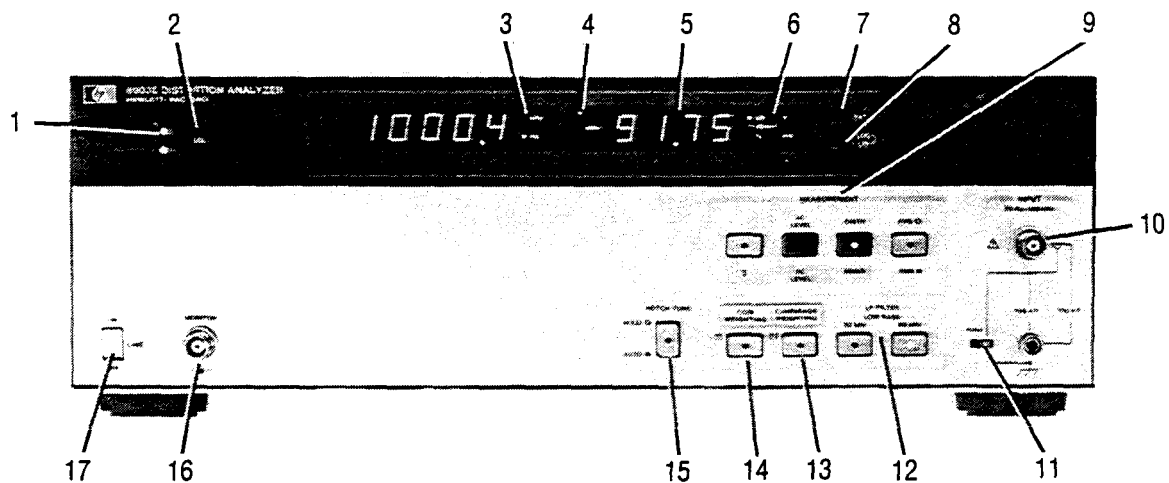



1. **HP-IB** Annunciators indicate remote operation status.
2. **LCL** (local) key returns the Distortion Analyzer to keyboard control from remote (HP-IB) control.
3. **Frequency Display** Annunciators indicate the frequency units.
4. **MEASUREMENT CYCLE** Indicator blinks after each measurement cycle.
5. The two **Numeric Displays** show the frequency, measurement results, error codes, or instrument or Special Function status.
6. **Measurement Display** Annunciators indicate the measurement result units.
7. **RATIO** key causes measurements to be displayed in % or dB relative to a reference.
8. **LOG/LIN** key causes results to be displayed in logarithmic or linear units.
9. **MEASUREMENT** keys command the Distortion Analyzer to make and display the selected measurement.
10. **INPUT** couples measurement signal into the instrument.
11. **FLOAT** switch provides floating input when required.
12. **LOW PASS** 30 kHz and 80 kHz filters reject high frequency noise.
13. **RIGHT-MOST OPTIONAL PLUG-IN FILTER** key selects the filter that is installed in the right-most filter slot. The C-Message Weighting (bandpass) Filter (Option 053) shown weights receiver testing according to BSTM 41004.
14. **LEFT-MOST OPTIONAL PLUG-IN FILTER** key selects the filter that is installed in the left-most filter slot. The CCIR Weighting (bandpass) Filter (Option 012) shown weights receiver testing according to CCIR Recommendation 468-2, DIN 45405.
15. **NOTCH TUNE** key switches the Notch Filter tune control between Auto Tuned and Hold mode (locking the Notch Filter at its current frequency setting).
16. **MONITOR OUTPUT** in ac level mode, provides a scaled voltage output representing the input signal. In SINAD, distortion, and distortion level modes, provides a scaled voltage output of the input signal with fundamental removed. Output impedance is 600Ω.
17. **LINE** switch applies power to the Distortion Analyzer when set to ON.

Figure 3-1. Front-Panel Features

### SIMPLIFIED OPERATION

#### Measurement

For ac level or distortion measurements, press:  or 

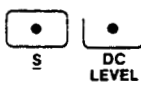
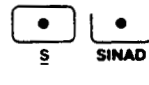
For dc level and SINAD measurements, press:  or 

#### Filters

**HP/BP Filter**

To activate any of the optional plug-in filters, press: 

**LP Filter**

To activate the LOW PASS 30 kHz filter, press: 

### RATIO and LOG/LIN

#### RATIO

To set the displayed measurement as the ratio reference, press:  .

#### LOG/LIN

To convert from linear to logarithmic (or from logarithmic to linear) measurement units, press:  .

Measurement Mode	RATIO on		RATIO off	
	LIN	LOG	LIN	LOG
AC LEVEL	%	dB	V or mV	dBm into 600Ω
DC LEVEL	%	dB	V or mV	dBm into 600Ω
SINAD	%	dB	%	dB
DISTN	%	dB	%	dB

#### NOTE

*During power up, the Distortion Analyzer is initialized and set to automatic operation.*

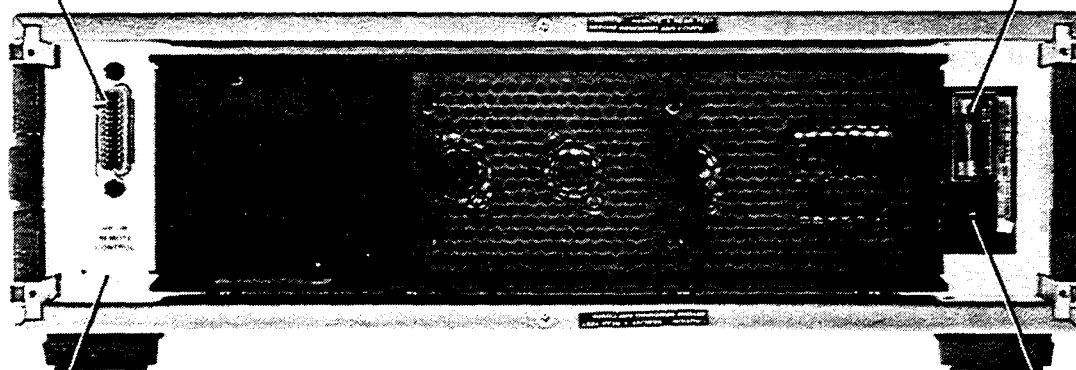

Table 3-2. Detailed Operating Instructions Table of Contents (Functional Listing)

Section	Page	Section	Page
<b>Measurements</b>		<b>Special Functions</b>	
AC Level .....	3-33	Detector Selection .....	3-41
Common Mode .....	3-36	Display Level in Watts (HP-IB controlled only) .....	3-42
DC Level .....	3-39	Error Disable .....	3-47
Detector Selection .....	3-41	Hold Decimal Point (HP-IB controlled only) .....	3-57
Distortion .....	3-43	Hold Settings (HP-IB controlled only) ....	3-58
Distortion Level (HP-IB controlled only) .....	3-45	HP-IB Address .....	3-59
SINAD .....	3-78	Input Level Range (DC Level) (HP-IB controlled only) .....	3-61
		Input Level Range (Except DC Level) (HP-IB controlled only) .....	3-62
<b>Filters</b>		Notch Tune .....	3-67
Filters (Low-Pass, High-Pass, Bandpass) .....	3-51	Post-Notch Detector Filtering (HP-IB controlled only) .....	3-68
Notch Tune .....	3-67	Post-Notch Gain (HP-IB controlled only) .	3-69
Post-Notch Detector Filtering .....	3-68	Read Display to HP-IB (HP-IB controlled only) .....	3-75
		Service Request Condition (HP-IB controlled only) .....	3-76
<b>Data Manipulation</b>		Special Functions (HP-IB controlled only) .....	3-80
Display Level in Watts (HP-IB controlled only) .....	3-42	Time Between Measurements (HP-IB controlled only) .....	3-86
Hold Decimal Point (HP-IB controlled only) .....	3-57		
Ratio and Log/Linear .....	3-73	<b>HP-IB</b>	
		HP-IB Address .....	3-59
<b>Errors</b>		Rapid Frequency Count .....	3-70
Error Disable .....	3-47	Read Display to HP-IB .....	3-75
Error Message Summary .....	3-48	Service Request Condition .....	3-76
<b>Inputs and Outputs</b>		<b>Miscellaneous</b>	
Float .....	3-55	Automatic Operation .....	3-35
Monitor .....	3-64	Default Conditions and Power-Up Sequence .....	3-40
		Float .....	3-55

**HP-IB Connector** connects the Distortion Analyzer to the Hewlett-Packard Interface Bus for remote operations. When in remote mode, the front-panel REMOTE annunciator lights.

**Fuse.** 1.50A (250V, time delay) for 100/120 Vac.  
0.75A (250V, time delay) for 220/240 Vac.



**Serial Number Plate.** First four numbers and letter comprise the prefix that denotes the instrument configuration. The last five digits form the suffix that is unique to each instrument.

**Line Power Module** permits operation from 100, 120, 220, or 240 Vac. The number visible in window indicates nominal line voltage to which instrument must be connected (see Figure 2-1). Center conductor is safety earth ground.

Figure 3-2. Rear Panel Features

## OPERATOR'S CHECKS

---

### 3-9 OPERATOR'S CHECKS

#### 3-10. Basic Functional Checks

**DESCRIPTION:** Using only an oscilloscope and an audio oscillator, the overall operation of the Distortion Analyzer is verified.

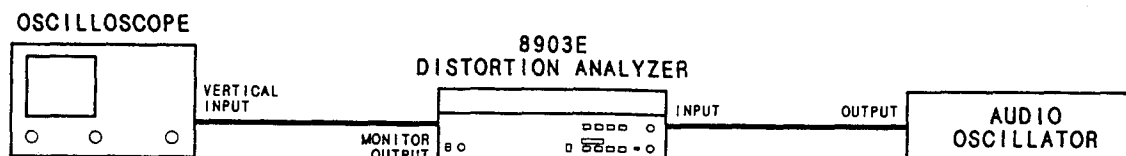

*Figure 3-3. Basic Functional Checks Setup*

**EQUIPMENT:** Audio Oscillator ..... HP339A or HP 8903B  
 Oscilloscope ..... HP1740A

**PROCEDURE: Preliminary Check**

1. Remove any cables from the Distortion Analyzer's INPUT. Set the LINE switch to OFF, and then back to ON and note that the front-panel LED annunciators, display segments and decimal points, and key lights turn on. All LEDs should light for approximately three seconds.
2. After the turn-on sequence, the left display should show 0.000 kHz and the right display should show a low flickering value in mV. In addition, the measurement cycle annunciator in the upper left-hand corner of the right display should be blinking and the AC LEVEL and LOW PASS 80 kHz keys should light.
3. Connect the audio oscillator output to the INPUT of the Distortion Analyzer with a BNC-to-BNC cable. Set the FLOAT switch to the ground position. See Figure 3-3.
4. Connect the oscilloscope to the MONITOR output. See Figure 3-3.
5. Set the audio oscillator to 1 V<sub>rms</sub> at 1 kHz. The left display should show the frequency of the audio oscillator, at approximately 1 kHz. The right display should show the amplitude of the audio oscillator, at approximately 1V. The oscilloscope should show a 1 kHz (1 ms period) sine wave of approximately 7 V<sub>pp</sub>.
6. Press the RATIO key. The RATIO light should light. The right display should show 100%.

#### NOTE

*In this and the following steps, the displays may vary a few least-significant digits.*

7. Press the AVG/RMS key. The AVG/RMS key should light. The right display should remain at approximately 100%.

**OPERATOR'S CHECKS**

8. Press the AVG/RMS key. The AVG/RMS key should light. Set the FLOAT switch to FLOAT. The right display should remain at approximately 100%.
9. Set the FLOAT switch back to ground. Press the LOG/LIN key. The right display should show 0.00 dB.

**Filter Check**

10. Adjust the frequency (but not the level) of the audio oscillator (to approximately 80 kHz) until the right display reads -3 dB. The left display should show between 72 and 88 kHz.
11. Press the LOW PASS 30 kHz key. The LOW PASS 30 kHz key light should light. Adjust the frequency (but not the level) of the audio oscillator (to approximately 30 kHz) until the right display reads -3 dB. The left display should show between 26 and 34 kHz.
12. Press the LOW PASS 30 kHz key again to turn it off. Set the audio oscillator to 100 kHz. The right display should show between -1 and 1 dB.
13. If the instrument has option 010 or 050 installed, press 400 Hz HIGH PASS. The 400 Hz HIGH PASS key light should light. Adjust the frequency of the audio oscillator (to approximately 400 Hz) until the right display reads -3 dB. The left display should show between 360 and 440 Hz.
14. Press the filter key listed in the following table for the filter option installed in the instrument. The respective key light should light. For each filter, set the audio oscillator frequency as shown in the following tables. Verify that the level ratio in the right display is within the limits shown for each frequency.

*Table for CCITT Weighting Filter (Option 011 or 051)*

Oscillator Frequency (Hz)	Ratio Limits (dB)
300	-12.1 to -9.1
800	-0.4 to +0.4
3 000	-7.1 to -4.1
3 500	-11.5 to -5.5
5 000	-40.0 to -32.0

*Table for CCIR Weighting Filter (Option 012 or 052)*

Oscillator Frequency (Hz)	Ratio Limits (dB)
31.5	-31.4 to -28.4
200	-14.5 to -13.1
6 300	+12.0 to +12.4
7 100	+11.7 to +12.3
10 000	+7.5 to +8.7
20 000	-23.7 to -20.7

---

**OPERATOR'S CHECKS**

---

*Table for C-Message Weighting Filter (Option 013 or 053)*

Oscillator Frequency (Hz)	Ratio Limits (dB)
100	-44.0 to -41.0
500	-9.0 to -6.0
1 000	-0.2 to +0.2
3 000	-4.0 to -1.0
5 000	-30.0 to -27.0

*Table for CCIR/ARM Weighting Filter (Option 014 or 054)*

Oscillator Frequency (Hz)	Ratio Limits (dB)
31.5	-37.0 to -34.0
200	-20.1 to -18.7
6 300	+6.4 to +6.8
7 100	+6.1 to +6.7
10 000	+1.9 to +3.1
20 000	-29.3 to -26.3

*Table for "A" Weighting Filter (Option 015 or 055)*

Oscillator Frequency (Hz)	Ratio Limits (dB)
50	-30.9 to -29.5
200	-11.7 to -10.3
1 000	-0.2 to +0.2
2 000	+0.5 to +1.9
10 000	-3.2 to -1.8
20 000	-10.8 to -7.8

**Distortion Check**

15. Set all filters on the Distortion Analyzer off. Press the LOW PASS 80 kHz key. Press the DISTN key. The DISTN key light should light.
16. Set the audio oscillator frequency to 1 kHz. The right display should show 0.01% or less.

**SINAD Check**

17. Press the S (Shift) SINAD keys. The SINAD key light should light. The right display should show 80 dB or more.
18. Press the Notch Tune key. The NOTCH TUNE KEY light should light.
19. Set the audio oscillator frequency to 890 Hz. The right display should show between 12 and 19 dB.

**DC Level Check**

20. Press the S (Shift) and DC LEVEL keys. The DC Level light should light. The right display should show between -10 and 10 mV. (With an ac voltage applied to the input, the reading will not be steady.)
-



---

## OPERATOR'S CHECKS

---

### 3-11. HP-IB Functional Checks

**DESCRIPTION:** The following ten procedures check the Distortion Analyzer's ability to process or send all of the applicable HP-IB messages described in Table 3-3. In addition, the Distortion Analyzer's ability to recognize its HP-IB address is checked and all of the bus data, handshake, and control lines except DIO8 (the most significant data line which is not used by the Distortion Analyzer) are set to both their true and false states. These procedures do not check whether or not all Distortion Analyzer program codes are being properly interpreted and executed by the instrument, however, if the front-panel operation is good, the program codes, in all likelihood will be correctly implemented.

The validity of these checks is based on the following assumptions:

- The Distortion Analyzer performs properly when operated via the front-panel keys (that is, in local mode). This can be verified with the Basic Functional Checks.
- The bus controller properly executes HP-IB operations.
- The bus controller's HP-IB interface properly executes the HP-IB operations.

If the Distortion Analyzer appears to fail any of these HP-IB checks, the validity of the above assumptions should be confirmed before attempting to service the instrument.

The select code of the controller's HP-IB interface is assumed to be 7. The address of the Distortion Analyzer is assumed to be 28 (its address as set at the factory). This select code-address combination (that is, 728) is not necessary for these checks to be valid. However, the program lines presented here would have to be modified for any other combination.

These checks are intended to be as independent of each other as possible. Nevertheless, the first four checks should be performed in order before other checks are selected. Any special initialization or requirements for a check are described at its beginning.

**INITIAL SETUP:** The test setup is the same for all of the checks. Connect the Distortion Analyzer to the bus controller via the HP-IB interface. Do not connect any equipment to the Distortion Analyzer's INPUT.

**EQUIPMENT:** HP-IB Controller . . . . . HP 9825A/98213A (General and Extended I/O ROM)  
                   —or—                  HP 85B option 007  
                   —or—                  HP 9000 Model 226 or any HP 9000 series 200 Computer

#### Address Recognition

**NOTE** This check determines whether or not the Distortion Analyzer recognizes when it is being addressed and when it is not. This check assumes only that the Distortion Analyzer can properly handshake on the bus. Before beginning this check, set the Distortion Analyzer's LINE switch to OFF, then to ON.



## OPERATOR'S CHECKS

---

Description	HPL	BASIC
Set the Remote Enable (REN) bus control line false.	lcl 7	LOCAL 7
Send the Distortion Analyzer's listen address.	wrt 728	OUTPUT 728

### OPERATOR'S RESPONSE

Check that the Distortion Analyzer's REMOTE annunciator is off and that its ADDRESSED annunciator is on.

Unaddress the Distortion Analyzer by sending a different address.	wrt 729	OUTPUT 729
---	---------	------------

### OPERATOR'S RESPONSE

Check that both the Distortion Analyzer's REMOTE and ADDRESSED annunciators are off.

### Remote and Local Messages and the LCL Key

#### NOTE

This check determines whether the Distortion Analyzer properly switches from local to remote control, from remote to local control, and whether the LCL key returns the instrument to local control. This check assumes that the Distortion Analyzer is able to both handshake and recognize its own address. Before beginning this check, set the Distortion Analyzer's LINE switch to OFF, then to ON.

Description	HPL	BASIC
Send the Remote message (by setting Remote Enable, REN, true and addressing the Distortion Analyzer to listen).	rem 728	REMOTE 728

### OPERATOR'S RESPONSE

Check that both the Distortion Analyzer's REMOTE and ADDRESSED annunciators are on.

Send the Local message to the Distortion Analyzer.	lcl 728	LOCAL 728
--	---------	-----------

### OPERATOR'S RESPONSE

Check that the Distortion Analyzer's REMOTE annunciator is off but its ADDRESSED annunciator is on.

Send the Remote message to the Distortion Analyzer.	rem 728	REMOTE 728
---	---------	------------

### OPERATOR'S RESPONSE

Check that both the Distortion Analyzer's REMOTE and ADDRESSED annunciators are on. Press the LCL key on the Distortion Analyzer. Check that the Distortion Analyzer's REMOTE annunciator is now off, but that its ADDRESSED annunciator remains on.

---



## OPERATOR'S CHECKS

---

### Sending the Data Message

**NOTE** This check determines whether or not the Distortion Analyzer properly issues Data messages when addressed to talk. This check assumes that the Distortion Analyzer is able to handshake and recognize its own address. Before beginning this check, set the Distortion Analyzer's LINE switch to OFF, then to ON, then after the power-up sequence is complete, press the DISTN key.

Description	HPL	BASIC
Address the Distortion Analyzer to talk and store its output data in variable V. (The output is E96 since there is no signal at its INPUT.)	red 728,V	ENTER 728;V
Display the value of V.	dsp V	PRINT V

**OPERATOR'S RESPONSE** Check that the Distortion Analyzer's REMOTE annunciator is off but that its ADDRESSED annunciator is on. The controller's display should read 9009600000.00 (HPL) or 9009600000 (BASIC).

### Receiving the Data Message

**NOTE** This check determines whether or not the Distortion Analyzer properly receives Data messages. The Data messages sent also cause the 7 least significant HP-IB data lines to be placed in both their true and false states. This check assumes the Distortion Analyzer is able to handshake, recognize its own address and properly make the remote/local transitions. Before beginning this check, set the Distortion Analyzer's LINE switch to OFF, then to ON.

Description	HPL	BASIC
Send the first part of the Remote message (enabling the Distortion Analyzer to remote).	rem 7	REMOTE 7
Address the Distortion Analyzer to listen (completing the Remote message), then send a Data message (selecting the Distortion measurement).	wrt 728,"M3"	OUTPUT 728;"M3"

**OPERATOR'S RESPONSE** Check that both the Distortion Analyzer's REMOTE and ADDRESSED annunciators are on. Check also that its Distortion key light is on.

### Local Lockout and Clear Lockout/Set Local Messages

**NOTE** This check determines whether or not the Distortion Analyzer properly receives the Local Lockout message, disabling all front-panel keys. The check also determines whether or not the Clear Lockout/Set Local message is properly received and executed by the Distortion Analyzer. This check assumes that the Distortion Analyzer is able to handshake, recognize its own address, and properly make the remote/local transitions. Before beginning this check, set the Distortion Analyzer's LINE switch to OFF, then to ON.

---





**OPERATOR'S CHECKS**

Description	HPL	BASIC
Send the first part of the Remote message (enabling the Distortion Analyzer to remote).	rem 7	REMOTE 7
Send the Local Lockout message.	llo 7	LOCAL LOCKOUT 7
Address the Distortion Analyzer to listen (completing the Remote message).	wrt 728	OUTPUT 728

**OPERATOR'S RESPONSE**

Check that both the Distortion Analyzer's REMOTE and ADDRESSED annunciators are on. Press the Distortion Analyzer's LCL key. Both its REMOTE and ADDRESSED annunciators should remain on.

Send the Clear Lockout/Set Local message.	lcl 7	LOCAL 7
---	-------	---------

**OPERATOR'S RESPONSE**

Check that the Distortion Analyzer's REMOTE annunciator is off but its ADDRESSED annunciator is on.

**Clear Message**

**NOTE**

This check determines whether or not the Distortion Analyzer properly responds to the Clear message. This check assumes that the Distortion Analyzer is able to handshake, recognize its own address, make the remote/local changes and receive Data messages. Before beginning this check set the Distortion Analyzer's LINE switch to OFF, then to ON.

Description	HPL	BASIC
Send the first part of the Remote message (enabling the Distortion Analyzer to remote).	rem 7	REMOTE 7
Address the Distortion Analyzer to listen (completing the Remote message), then send a Data message that selects the Distortion measurement.	wrt 728,"M3"	OUTPUT 728;"M3"

**OPERATOR'S RESPONSE**

Check that both the Distortion Analyzer's REMOTE and ADDRESSED annunciators are on and that the Distortion key light is also on.

Send the Clear message (setting the Distortion Analyzer's measurement to AC LEVEL).	clr 728	RESET 728
---	---------	-----------

**OPERATOR'S RESPONSE**

Check that both the Distortion Analyzer's REMOTE and ADDRESSED annunciators are on and that the AC LEVEL key light is on.



**OPERATOR'S CHECKS**

**Abort Message**

**NOTE**

This check determines whether or not the Distortion Analyzer becomes unaddressed when it receives the Abort message. This check assumes that the Distortion Analyzer is able to handshake, recognize its own address, make the remote/local changes, and enter serial poll mode. Before beginning this check, set the Distortion Analyzer's LINE switch to OFF, then to ON.

Description	HPL	BASIC
Send the Remote message to the Distortion Analyzer.	rem 728	REMOTE 728

**OPERATOR'S RESPONSE**

Check that both the Distortion Analyzer's REMOTE and ADDRESSED annunciators are on.

Send the Abort message, unaddressing the Distortion Analyzer to listen.	cli 7	ABORTIO 7
---	-------	-----------

**OPERATOR'S RESPONSE**

Check that the Distortion Analyzer's ADDRESSED annunciator is off. Note that the BASIC "ABORTIO" statement sends both the Abort message and the Local message. Thus if HPL is being used, the Distortion Analyzer's REMOTE annunciator should remain on. If BASIC is being used, the Distortion Analyzer's REMOTE annunciator should turn off.

Send the Local message (HPL only).	lcl 7	(The Local message was already sent with the ABORTIO 7 statement above.)
Address the Distortion Analyzer to talk and store its output data in variable V.	red 728,V	ENTER 728;V.

**OPERATOR'S RESPONSE**

Check that the Distortion Analyzer's REMOTE annunciator is off but that its ADDRESSED annunciator is on.

Send the Abort message, unaddressing the Distortion Analyzer to talk.	cli 7	ABORTIO 7
---	-------	-----------

**OPERATOR'S RESPONSE**

Check that both the Distortion Analyzer's REMOTE and ADDRESSED annunciators are off.



**OPERATOR'S CHECKS**

Send the serial poll-enable bus command (SPE) through the interface to place the Distortion Analyzer in serial-poll mode.	wti 0,7; wti 6,24	SENBUS 728; 1,24
Send Special Function 61.3	wrt 728,"61.3SP"	OUTPUT 728; "61.3SP"

**OPERATOR'S RESPONSE**

On the Distortion Analyzer, the right display should show 1.0. This indicates the Distortion Analyzer is in serial-poll mode (indicated by the "1").

Send the Abort message, removing the Distortion Analyzer from serial-poll mode.	cli 7	ABORTIO 7
---	-------	-----------

**OPERATOR'S RESPONSE**

Check that the Distortion Analyzer's right display shows 0.0. This indicates the Distortion Analyzer properly left serial-poll mode upon receiving the Abort message.

**Status Byte Message**

**NOTE**

This check determines whether or not the Distortion Analyzer sends the Status Byte message in both the local and remote modes. This check assumes that the Distortion Analyzer is able to handshake, recognize its own address, and make the remote/local changes. Before beginning this check, set the Distortion Analyzer's LINE switch to OFF, then to ON.

Description	HPL	BASIC
Place the Distortion Analyzer in serial-poll mode and address it to talk (causing it to send the Status Byte message).	rds (728) → V	STATUS 728;V
Display the value of V.	dsp V	PRINT V

**OPERATOR'S RESPONSE**

Check that Distortion Analyzer's REMOTE annunciator is off. Depending upon the vintage of the HP-IB interface (HPL) used, the Distortion Analyzer's ADDRESSED annunciator may be either on or off. The controller's display should read 0.00 (HPL) or 0 (BASIC).

Send the Remote message.	rem 728	REMOTE 728
Place the Distortion Analyzer in serial-poll mode and address it to talk (causing it to send the Status Byte message).	rds (728) → V	STATUS 728;V
Display the value of V.	dsp V	PRINT V

**OPERATOR'S RESPONSE**

Check that the Distortion Analyzer's REMOTE annunciator is on. Depending upon the vintage of the HP-IB HPL interface used, the Distortion Analyzer's ADDRESSED annunciator may be either on or off. The controller's display should read 0.00 (HPL) or 0 (BASIC).



**OPERATOR'S CHECKS**

**Require Service Message**

**NOTE** This check determines whether or not the Distortion Analyzer can issue the Require Service message (set the SRQ bus control line true). This check assumes that the Distortion Analyzer is able to handshake, recognize its own address, make the remote/local changes, and receive Data messages. Before beginning this check, set the Distortion Analyzer's LINE switch to OFF, then to ON, then after the power-up sequence is complete, press the DISTN key.

Description	HPL	BASIC
Send the first part of the Remote message (enabling the Distortion Analyzer to remote).	rem 7	REMOTE 7
Address the Distortion Analyzer to listen (completing the Remote message) then send a Data message (enabling a Require Service message to be sent upon Instrument Error).	wrt 728,"22.4SP"	OUTPUT 728;"22.4SP"
Make the controller wait 2 seconds to allow time for the Distortion Analyzer to send the Require Service message. (This step is not necessary if sufficient time is allowed.)	wait 2000	WAIT 2000
Read the binary status of the controller's HP-IB interface and store the data in variable V (in this step, 7 is the interface's select code).	rds (7) → V	STATUS 7; V
Display the value of the SRQ bit (in (in this step, 7 is the SRQ bit, numbered from 0).	dsp"SRQ=",bit (7,V)	PRINT "SRQ=";BIT (V,7)

**OPERATOR'S RESPONSE** Check that the SRQ value is 1, indicating the Distortion Analyzer issued the Require Service message.

**Trigger Message and Clear Key Triggering**

**NOTE** This check determines whether or not the Distortion Analyzer responds to the Trigger message and whether the CLEAR key serves as a manual trigger in remote. This check assumes that the Distortion Analyzer is able to handshake, recognize its own address, make the remote/local changes, and send and receive Data messages. Before beginning this check, set the Distortion Analyzer's LINE switch to OFF, then to ON, then, when the power-up sequence is complete, press the DISTN key.



**OPERATOR'S CHECKS**

Description	HPL	BASIC
Send the first part of the Remote message (enabling the Distortion Analyzer to remote).	rem 7	REMOTE 7
Address the Distortion Analyzer to listen (completing the Remote message), then send a Data message (placing the Distortion Analyzer in Hold mode).	wrt 728, "T1"	OUTPUT 728; "T1"
Send the Trigger message.	trg 728	TRIGGER 728
Address the Distortion Analyzer to talk and store the data in variable V.	red 728, V	ENTER 728;V
Display the value of V.	dsp V	PRINT V

**OPERATOR'S RESPONSE**

Check that both the Distortion Analyzer's REMOTE and ADDRESSED annunciators are on. The controller's display should read 9009600000.00 (HPL) or 9009600000 (BASIC).

Address the Distortion Analyzer to talk and store the data in variable V.	red 728,V	ENTER 728;V
---	-----------	-------------

**OPERATOR'S RESPONSE**

Check that the controller's "run" indicator is still on indicating that it has not received data from the Distortion Analyzer. Press the Distortion Analyzer's S (Shift) AVG/RMS keys (instrument clear). The controller's "run" indicator should turn off.



### 3-12. REMOTE OPERATION, HEWLETT-PACKARD INTERFACE BUS

The Distortion Analyzer can be operated through the Hewlett-Packard Interface Bus (HP-IB). Bus compatibility, programming, and data formats are described in the following paragraphs.

Except for the LINE switch, the low terminal ground/FLOAT switch, and the Controller Reset Service Special Function, all Distortion Analyzer operations (including service related functions) are fully programmable via HP-IB. In addition, rapid frequency count capabilities (not available from the front-panel) are provided in remote operation. All the Special Functions and the distortion level measurement mode are available only through HP-IB control.

A quick test of the HP-IB I/O is described under HP-IB Functional Checks. These checks verify that the Distortion Analyzer can respond to or send each of the applicable bus messages described in Table 3-3.

For more information about HP-IB, refer to IEEE Standard 488, ANSI Standard MC1.1, the Hewlett-Packard Electronic Systems and Instruments catalog, and the booklet, "Improving Measurements in Engineering and Manufacturing" (HP part number 5952-0058).

#### 3-13. HP-IB Compatibility

The Distortion Analyzer's complete bus compatibility (as defined by IEEE Standard 488, and the identical ANSI Standard MC1.1) is described at the end of Table 3-3. Table 3-3 also summarizes the Distortion Analyzer's HP-IB capabilities in terms of the twelve bus messages in the left-hand column.

#### 3-14. Remote Mode

**Remote Capability.** In remote, most of the Distortion Analyzer's front-panel controls are disabled (exceptions are the LCL key and the Clear Key Function, S (Shift) AVG/RMS). However, front-panel displays and the signal at various outputs remain active and valid. In remote, the Distortion Analyzer may be addressed to talk or listen. When addressed to listen, the Distortion Analyzer will respond to the Data, Trigger, Clear (SDC), and Local messages. When addressed to talk, the Distortion Analyzer can issue the Data and Status Byte messages. Whether addressed or not, the Distortion Analyzer will respond to the Clear (DCL), Local Lockout, Clear Lockout/Set

Local, and Abort messages, and in addition, the Distortion Analyzer may issue the Require Service message. Local-to-Remote Mode Changes. The Distortion Analyzer switches to remote operation upon receipt of the Remote message. The Remote message has two parts. They are:

- Remote enable bus control line (REN) set true
- Device listen address received once (while REN is true)

When the Distortion Analyzer switches to remote, both the REMOTE and ADDRESSED annunciators on its front panel will turn on.

#### 3-15. Local Mode

**Local Capability.** In local, the Distortion Analyzer's front-panel controls are fully operational and the instrument will respond to the Remote message. Whether addressed or not, it will also respond to the Clear, Local Lockout, Clear Lockout/Set Local, and the Abort messages. When addressed to talk, the instrument can issue Data messages and the Status Byte message, and whether addressed or not, it can issue the Require Service message.

**Remote-to-Local Mode Changes.** The Distortion Analyzer always switches to local from remote whenever it receives the Local message (GTL) or the Clear Lockout/Set Local message. (The Clear Lockout/Set Local message sets the Remote Enable control line [REN] false.) If it is not in Local Lockout mode, the Distortion Analyzer switches to local from remote whenever its front panel LCL key is pressed.

#### 3-16. Addressing

The Distortion Analyzer interprets the byte on the bus' eight data lines as an address or a bus command if the bus is in the command mode: attention control line (ATN) true and interface clear control line (IFC) false. Whenever the Distortion Analyzer is being addressed (whether in local or remote), the ADDRESSED annunciator on the front-panel will turn on.

The Distortion Analyzer talk and listen addresses are switch selectable as described under paragraph 2-7 in Section 2. Refer to Table 2-1 for a comprehensive listing of all valid HP-IB address codes. To determine the present address setting, refer to the discussion titled HP-IB Address in the Detailed Operating Instructions near the end of this section.



Table 3-3. Message Reference Table (1 of 2)

HP-IB Message	Applicable	Response	Related Commands and Controls	Interface Functions*
Data	Yes	All Distortion Analyzer operations except the LINE and FLOAT switch functions are bus-programmable. All measurement results, special displays, and error outputs except the "----" display are available to the bus.		AH1 SH1 T5, TE0 L3, LE0
Trigger	Yes	If in remote and addressed to listen, the Distortion Analyzer makes a settled measurement according to previously programmed setup. It responds equally to bus command GET and program code T3, Trigger with Settling (a Data message).	GET	DT1
Clear	Yes	Sets MEASUREMENT to AC LEVEL with the 80 kHz LP FILTER on, and sets the trigger mode to free run. Resets many additional parameters as shown in Table 3-5. Clears Status Byte, RQS bit, Require Service message (if issued) and Local Lockout. Sets the Service Request Condition to the 22.2 state. Responds equally to Device Clear (DCL) and Selected Device Clear (SDC) bus commands.	DCL SDC	DC1
Remote	Yes	Remote mode is enabled when the REN bus control line is true. However, remote mode is not entered until the first time the Distortion Analyzer is addressed to listen. The front-panel REMOTE annunciator lights when the instrument is actually in the remote mode. When entering remote mode, no instrument settings or functions are changed, but all front-panel keys except LCL are disabled, and entries in progress are cleared.	REN	RL1
Local	Yes	The Distortion Analyzer returns to local mode (front-panel control). Responds equally to the GTL bus command and the front-panel LCL key. When entering local mode, no instrument settings or functions are changed but entries in progress are cleared. In local, triggering is free run only.	GTL	RL1
Local Lockout	Yes	Disables all front-panel keys including LCL. Only the controller can return the Distortion Analyzer to local (front-panel control).	LLO	RL1
Clear Lockout/ Set Local	Yes	The Distortion Analyzer returns to local (front-panel control) and local lockout is cleared when the REN bus control line goes false. When entering local mode, no instrument settings or functions are changed, but entries in progress are cleared. In local, triggering is free run only.	REN	RL1
Pass Control/ Take Control	No	The Distortion Analyzer has no control capability.		C0
Require Service	Yes	The Distortion Analyzer sets the SRQ bus control line true if an invalid program code is received. The Distortion Analyzer will also set SRQ true, if enabled by the operator to do so, when measurement data is ready or when an instrument error occurs.	SRQ	SR1

\*Commands, Control lines, and Interface Functions are defined in IEEE Std. 488. Knowledge of these might not be necessary if your controller's manual describes programming in terms of the twelve HP-IB Messages shown in the left column.



Table 3-3. Message Reference Table (2 of 2)

HP-IB Message	Applicable	Response	Related Commands and Controls	Interface Functions*
Status Byte	Yes	The Distortion Analyzer responds to a Serial Poll Enable (SPE) bus command by sending an 8-bit byte when addressed to talk. If the instrument is holding the SRQ control line true (issuing the Require Service message) bit 7 (RQS bit) in the Status Byte and the bit representing the condition causing the Require Service message to be issued will both be true. The bits in the Status Byte are latched but can be cleared by: 1) removing the causing condition, and 2) reading the Status Byte.	SPE SPD	T5, TE0
Status Bit	No	The Distortion Analyzer does not respond to a parallel poll.		PP0
Abort	Yes	The Distortion Analyzer stops talking and listening.	IFC	T5, TE0 L3, LE0
*Commands, Control lines, and Interface Functions are defined in IEEE Std. 488. Knowledge of these might not be necessary if your controller's manual describes programming in terms of the twelve HP-IB Messages shown in the left column.				

Complete HP-IB capability as defined in IEEE Std. 488 and ANSI Std. MC1.1 is: SH1, AH1, T5, TE0, L3, LE0, SR1, RL1, PP0, DC1, DT1, C0, E1.

**Local Lockout.** When a data transmission is interrupted, which can happen by returning the Distortion Analyzer to local mode by pressing the LCL key, the data could be lost. This would leave the Distortion Analyzer in an unknown state. To prevent this, a local lockout is recommended. Local lockout disables the LCL key (and the Clear Key Function, S (Shift) AVG/RMS) and allows return-to-local only under program control.

**NOTE**

*Return-to-local can also be accomplished by turning the Distortion Analyzer's LINE switch to OFF, then back to ON. However, this technique has several disadvantages:*

- *It defeats the purpose and advantages of local lockout (that is, the system controller will lose control of a system element).*
- *There are several HP-IB conditions that reset to default states at turn-on.*

**3-17. Data Messages**

The Distortion Analyzer communicates on the interface bus primarily with data messages. Data messages consist of one or more bytes sent over the 8 data bus lines, when the bus is in the data mode (attention

control line [ATN] false). Unless it is set to Talk Only, the Distortion Analyzer receives data messages when addressed to listen. Unless it is set to Listen Only, the Distortion Analyzer sends data messages or the Status Byte message (if enabled) when addressed to talk. Virtually all instrument operations available in local mode may be performed in remote mode via data messages. The only exceptions are changing the LINE switch and the FLOAT switch. In addition, the Distortion Analyzer may be triggered via data messages to make measurements at a particular time.

**3-18. Receiving the Data Message**

Depending on how the internal address switches are set, the Distortion Analyzer can either talk only, talk status only, listen only, or talk and listen both (normal operation). The instrument responds to Data messages when it is enabled to remote (REN control line true) and it is addressed to listen or set to Listen Only. If not set to Listen Only, the instrument remains addressed to listen until it receives an Abort message or until its talk address or a universal unlisten command is sent by the controller.

**Listen Only.** If the internal LON (Listen Only) switch is set to "1", the Distortion Analyzer is placed in the





Listen Only mode when the remote enable bus control line (REN) is set true. The instrument then responds to all Data messages, and the Trigger, Clear, and Local Lockout messages. However, it is inhibited from responding to the Local or Abort messages and from responding to a serial poll with the Status Byte message.

Listen Only mode is provided to allow the Distortion Analyzer to accept programming from devices other than controllers (for example, card readers).

**Data Input Format.** The Data message string, or program string, consists of a series of ASCII codes. Each code is typically equivalent to a front-panel keystroke in local mode. Thus, for a given operation, the program string syntax in remote mode is the same as the keystroke sequence in local mode. Example 1 shows the general case programming order for selecting Distortion Analyzer functions. Specific program order considerations are discussed in following paragraphs under "Program Order Considerations". All functions can be programmed together as a continuous string as typified in Example 2. The string in Example 2 clears most Special Functions (with Automatic Operation), selects a distortion measurement with 30 kHz low-pass filtering and log units, then triggers a settled measurement.

**Program Codes.** All of the valid HP-IB codes for controlling Distortion Analyzer functions are summarized in Table 3-6. All front-panel keys except the LCL key have corresponding program codes.

Table 3-4 shows the Distortion Analyzer's response to various ASCII characters not used in its code set. The characters in the upper table will be ignored

unless they appear between two characters of a program code. The characters in the lower table, if received by the Distortion Analyzer, will always cause Error 24 (invalid HP-IB code) to be displayed and a Require Service message to be generated. The controller recognizes the invalid code entry and clears the Require Service condition. Thereafter, the invalid code entry is ignored, and subsequent valid entries are processed in normal fashion. As a convenience, all lower case alpha characters are treated as upper case.

In addition to the ignored codes given in Table 3-4, codes used in the HP 8903A and 8903B Audio Analyzers but not common to the Distortion Analyzer are ignored. (They do not generate an error message.) For example, the output code "AP1VL", which sets the audio analyzer's source to 1V, will be ignored.

Table 3-4. Distortion Analyzer Response to Unused ASCII Codes

Ignored†				
!	#	(	,	
"	%	)	/	
"	&	*		
Generate Error 24				
@	I	Z	^	}
B	J	[	_	~
E	Q	\	{	DEL
G	Y	]		

†Except when inserted between two characters of a program code.

**EXAMPLE 1: General Program Syntax and Protocol\***

{ Controller Talk  
Audio Analyzer Listen }

[Automatic Operation] [Measurement] [Filters] [Special Functions] [Log/Lin] [Ratio] [Trigger]

\*Excluding Rapid Frequency Count Mode.

**EXAMPLE 2: Typical Program String**

{ Controller Talk  
Audio Analyzer Listen }

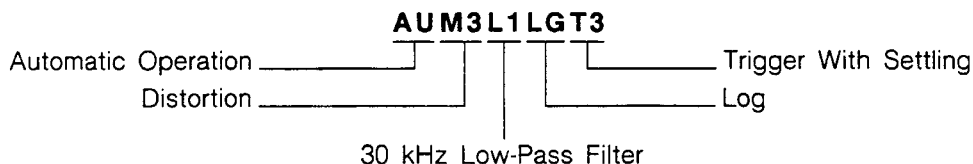



**Turning off Functions.** When operating in local mode the High-Pass/Bandpass (optional plug-in filters) and Low-Pass Filters and the Notch Tune, the AVG/RMS, and Ratio functions toggle on and off with successive keystrokes. In remote mode, these functions do not toggle on and off. Instead, each of the above groups has a specific code which turns off all the keys in the group. The HP-IB codes for turning off these functions are given in the table below.

Function	HP-IB Code
Average off (returns to RMS mode)	A0
HP/BP FILTERS all off	H0
LP FILTERS all off	L0
NOTCH HOLD off	N0
RATIO off	R0

**Programming Numeric Data.** When entering ratio references to the Distortion Analyzer, certain precautions should be observed. Numeric data may be entered in fixed, floating point, or exponential formats. Usually, numeric data consists of a signed mantissa of up to five digits (including leading zeros), one decimal point, and one- or two-digit signed exponent. The decimal point may fall between any two digits of the mantissa but should not appear ahead of the first digit. If it does, a leading zero will be automatically inserted by the Distortion Analyzer. Any digit beyond the five allowed for the mantissa will be received as zero. The general format for numeric data entry is given below, followed by several examples illustrating various entries and the resulting data as received by the Distortion Analyzer.

**General Numeric Data Input Format:**

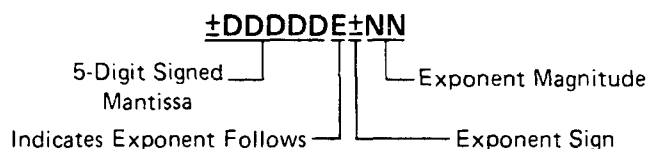

- Example: + .12345E+01 issued
- Example: 0.12340E+01 received by Distortion Analyzer
- Example: +123456E+01 issued
- Example: +123450E+01 received by Distortion Analyzer
- Example: +00012345 issued
- Example: 12000 received by Distortion Analyzer

In general, do not issue numeric data with more significant digits than can be displayed on the Distortion Analyzer's five-digit left display.

**Triggering Measurements with the Data Message.** A feature that is only available via remote programming is the selection of free run, standby, or triggered operation of the Distortion Analyzer. During local operation the Distortion Analyzer is allowed to free run, outputting data to the display as each measurement is completed. In remote, three additional operating modes are allowed: Hold, Trigger Immediate, and Trigger with Settling. In addition, the Clear Key Function can act as a manual trigger while the instrument is in remote. The trigger modes and use of the Clear Key Function are described below.

**Free Run (T0).** This mode is identical to local operation and is the mode of operation in effect when no other trigger mode has been selected. The measurement result data available to the bus are constantly being updated as rapidly as the Distortion Analyzer can make measurements. A Device Clear message or entry into remote from local sets the Distortion Analyzer to the Free Run mode.

**Hold (T1).** This mode is used to set up triggered measurements (initiated by program codes T2 or T3, the Trigger message, or the Clear Key Function explained below). In Hold mode, internal settings can be altered by the instrument itself or by the user via the bus. Thus, the signal at the MONITOR output can change. However, the instrument is inhibited from outputting any data to the front-panel key lights and display, or to the HP-IB except as follows. The instrument will issue the Require Service message or if an HP-IB code error occurs. The instrument will issue the Status Byte message if serial polled. (A serial poll, however, will trigger a new measurement, update displays, and return the instrument to Hold.)

Upon leaving Hold, the front-panel indications are updated as the new measurement cycle begins. The Status Byte will be affected (and the Require Service message issued) by the events that occur during the new measurement cycle. The Distortion Analyzer leaves Hold when it receives either the Free Run, Trigger Immediate, Trigger with Settling codes, or the Trigger Message, when the S (Shift) AVG/RMS keys (the Clear Key Function) are pressed (if not in Local Lockout), or when it returns to local operation.

**Trigger Immediate (T2).** When the Distortion Analyzer receives the Trigger Immediate code, it makes one measurement in the shortest possible time. The instrument then waits for the measurement results to be read. While waiting, the instrument can



process most bus commands without losing the measurement results. However, if the instrument receives GTL (Go To Local), GET (Group Execute Trigger), or its listen address or if it is triggered by the Clear Key Function, a new measurement cycle will be executed. Once the data (measurement results) are read onto the bus, the Distortion Analyzer reverts to the Hold mode. Measurement results obtained via Trigger Immediate are normally valid only when the instrument is in a steady, settled state.

**Trigger with Settling (T3).** Trigger with Settling is identical to Trigger Immediate except the Distortion Analyzer inserts a settling-time delay before taking the requested measurement. This settling time is sufficient to produce valid, accurate measurement results. Trigger with Settling is the trigger type executed when a Trigger message is received via the bus.

**Triggering Measurements with the Clear Key Function.** When the Distortion Analyzer is in remote Hold and not in Local Lockout, the front-panel Clear Key Function may be used to issue a Trigger with Settling instruction. First place the instrument in Hold mode (code T1). Trigger the measurement by pressing the S (Shift) and AVG/RMS keys. Each time this key sequence is entered the Distortion Analyzer performs one Trigger with Settling Measurement cycle, then waits for the data to be read. Once the data is read out to the bus, the instrument returns to Hold mode. If data is not read between trigger cycles, it will be replaced with data acquired from subsequent measurements.

**Special Considerations for Triggered Operation.** When in free-run mode, the Distortion Analyzer must pay attention to all universal bus commands, for example, serial poll enable (SPE), local lockout (LLO), etc. In addition, if it is addressed to listen, it must pay attention to all addressed bus commands, for example, Go To Local (GTL), Group Execute Trigger (GET), etc. As a consequence of this, the Distortion Analyzer must interrupt the current measurement cycle to determine whether any action in response to these commands is necessary. Since many elements of the measurements are transitory, the measurement must be re-initiated following each interruption. Thus, if much bus activity occurs while the Distortion Analyzer is trying to take a measurement, that measurement may never be completed.

Trigger Immediate and Trigger with Settling provide a way to avoid this problem. When the Trigger Immediate (T2) and Trigger with Settling (T3) codes are received, the Distortion Analyzer will not allow its measurement to be interrupted. (Indeed, handshake

of bus commands is inhibited until the measurement is complete.) Once the measurement is complete, bus commands will be processed, as discussed under Trigger Immediate above, with no loss of data. Thus, in an HP-IB environment where many bus commands are present, Trigger Immediate or Trigger with Settling should be used for failsafe operation.

**Reading Data from the Right or Left Display.** The Distortion Analyzer can only read data to the HP-IB once for each measurement made. Only the information on one display can be read each time. Use the codes RR (read right display) or RL (read left display) to control which information is read. The display will remain selected until the opposing display is specified (or until a clear message is received or power-up occurs). Errors (which occupy two displays) are output as described above, and DC LEVEL measurement results (always occupying the right display only) are placed on the bus (when requested) regardless of which display is enabled.

**Program Order Considerations.** Although program string syntax is virtually identical to keystroke order, some program order considerations need highlighting.

**Automatic Operation (AU).** When Automatic Operation is executed in remote only, it sets all Special Functions prefixed 1 through 8 to their zero-suffix mode and also affects many other Special Functions. Thus when Automatic Operation is used, it should appear at the beginning of a program string.

**Trigger Immediate and Trigger with Settling (T2 and T3).** When either of the trigger codes T2 or T3 is received by the Distortion Analyzer, a measurement is immediately initiated. Once the measurement is complete, some bus commands can be processed without losing the measurement results. However, any HP-IB program code sent to the Distortion Analyzer before the triggered measurement results have been output will initiate a new measurement. Thus, trigger codes should always appear at the end of a program string, and the triggered measurement results must be read before any additional program codes are sent.

### 3-19. Sending the Data Message

Depending on how the internal address switches are set, the Distortion Analyzer can either talk only, talk status only, listen only, or talk and listen both (normal operation). If set to both talk and listen, the instrument sends Data messages when addressed to talk. The instrument then remains configured to talk until it is unaddressed to talk by the controller. To unaddress the Distortion Analyzer, the controller must send either an Abort message, a new talk address, or a universal untalk command.



**Talk Only Mode.** If the internal address switches are set to a valid Talk address and the TON (Talk Only) switch is set to "1", the Distortion Analyzer is placed in the Talk Only mode. In this mode instrument is configured to send Data messages whenever the bus is in the data mode. Each time the measurement is completed, the measurement result will be output to the bus unless the listening device is not ready for data. If the listener is not ready and the Distortion Analyzer is not in a trigger mode, another measurement cycle is executed.

**Talk Status Only Mode.** If all the internal address switches and the TON (Talk Only) switch are set to "1", but the LON (Listen Only) switch is set to "0", the Distortion Analyzer is placed in the Talk Status Only mode. In this mode the instrument is configured to send a one-byte data message whenever the bus is in the data mode. The byte sent is an exact copy of the Status Byte. Each time this byte is successfully sent on the bus, the internal Status Byte is cleared. The Data Valid (DAV) handshake line is pulsed each time the one-byte Data message is sent.

**Data Output Format.** As shown below, the output data is usually formatted as a real constant in exponential form: first the sign, then five digits (leading zeros not suppressed) followed by the letter E and a signed power-of-ten multiplier. (Refer to *Rapid Frequency Count* in the *Detailed Operation Instructions* for the only exception to this format.) The string is terminated by a carriage return (CR) and a line feed (LF), string positions 11 and 12. Data is always output in fundamental units (for example, Hz, volts, dB, %, etc.), and the decimal point (not sent) is assumed to be to the right of the fifth digit of the mantissa. Data values never exceed 4 000 000 000.

**Data Output Format:**

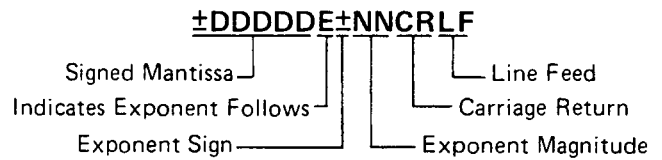

**NOTE**

*For the only exception to the above format, refer to Rapid Frequency Count in the Detailed Operating Instructions.*

When an error is output to the bus, it follows the same twelve-byte format described above except most of the numeric digits have predetermined values as shown below. Error outputs always exceed 9 000 000 000. The two-digit error code is represented by the last two digits of the five-digit mantissa. The error code can be derived from the string by subtracting  $9 \times 10^9$ , then dividing the results by 100 000.

**Error Output Format:**

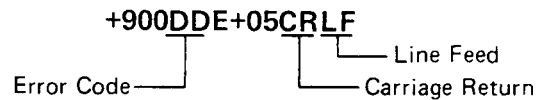

**3-20. Receiving the Clear Message**

The Distortion Analyzer responds to the Clear message by assuming the settings detailed in Table 3-5. The Distortion Analyzer responds equally to the Selected Device Clear (SDC) bus command when addressed to listen, and the Device Clear (DCL) bus command whether addressed or not. The Clear message clears any pending Require Service message and resets the Service Request Condition (Special Function 22) such that the Require Service message will be issued on HP-IB code errors only (Special Function 22.2).

Table 3-5. Response to a Clear Message

Parameter	Setting
Measurement	AC Level
Detection	RMS
Low-Pass (LP) Filter	80 kHz Low-Pass On
High-Pass (HP)/ Bandpass (BP) (optional plug-in Filters)	All off
Special Functions	All Special Functions off or set to their zero-suffix mode except Service Request Condition set to 22.2 (HP-IB code error).
Ratio	Off
Log/Lin	Linear (Refer to RATIO and LOG/LIN Detailed Operating Instructions.)
Right Display Read	Enabled
Service Request Condition	HP-IB Code Error Only
Status Byte	Cleared
Trigger Mode	Free Run (Code T0)
Local Lockout	Cleared



### 3-21. Receiving the Trigger Message

When in remote and addressed to listen, the Distortion Analyzer responds to a Trigger message by executing one settled-measurement cycle. The Distortion Analyzer responds equally to a Trigger message (the Group Execute Trigger bus command [GET]) and a Data message, program code T3 (Trigger with Settling). Refer to "Triggering Measurements with the Data Message" under paragraph 3-18, *Receiving the Data Message*.

### 3-22. Receiving the Remote Message

The Remote message has two parts. First, the remote enable bus control line (REN) is held true, then the device listen address is sent by the controller. These two actions combine to place the Distortion Analyzer in remote mode. Thus, the Distortion Analyzer is enabled to go into remote when the controller begins the Remote message, but it does not actually switch to remote until addressed to listen the first time. No instrument settings are changed by the transition from local to remote, but the Trigger mode is set to Free Run (code T0). When actually in remote, the Distortion Analyzer lights its front-panel REMOTE annunciator. When the Distortion Analyzer is being addressed (whether in remote or local), its front-panel ADDRESSED annunciator turns on.

### 3-23. Receiving the Local Message

The Local message is the means by which the controller sends the Go To Local (GTL) bus command. If addressed to listen, the Distortion Analyzer returns to front-panel control when it receives the Local message. If the instrument was in local lockout when the Local message was received, front-panel control is returned, but lockout is not cleared. Unless it receives the Clear Lockout/Set Local message, the Distortion Analyzer will return to local lockout the next time it goes to remote. No instrument settings are changed by the transition from remote to local, but all measurements are made in a free run mode.

When the Distortion Analyzer goes to local mode, the front-panel REMOTE annunciator turns off. However, when the Distortion Analyzer is being addressed (whether in remote or local), its front-panel ADDRESSED annunciator lights.

If the Distortion Analyzer is not in local lockout mode, pressing the front-panel LCL (local) key might interrupt a Data message being sent to the instrument, leaving the instrument in a state unknown to the controller. This can be prevented by disabling the Distortion Analyzer's front-panel keys entirely using the Local Lockout message.

### 3-24. Receiving the Local Lockout Message

The Local Lockout message is the means by which the controller sends the Local Lockout (LLO) bus command. If in remote, the Distortion Analyzer responds to the Local Lockout Message by disabling the front-panel LCL (local) key and the Clear Key Function. (In remote, the Clear Key Function initiates a Trigger with Settling cycle.) The local lockout mode prevents loss of data or system control due to someone accidentally pressing front-panel keys. If, while in local, the Distortion Analyzer is enabled to remote (that is, REN is set true) and it receives the Local Lockout message, it will switch to remote mode with local lockout the first time it is addressed to listen. When in local lockout, the Distortion Analyzer can be returned to local only by the controller (using the Local or Clear Lockout/Set Local messages), or by setting the LINE switch to OFF and back to ON, or by removing the bus cable.

### 3-25. Receiving the Clear Lockout/Set Local Message

The Clear Lockout/Set Local message is the means by which the controller sets the Remote Enable (REN) bus control line false. The Distortion Analyzer returns to local mode (full front-panel control) when it receives the Clear Lockout/Set Local message. No instrument settings are changed by the transition from remote with local lockout to local. When the Distortion Analyzer goes to local mode, the front-panel REMOTE annunciator turns off.

### 3-26. Receiving the Pass Control Message

The Distortion Analyzer does not respond to the Pass Control message because it cannot act as a controller.

### 3-27. Sending the Require Service Message

The Distortion Analyzer sends the Require Service message by setting the Service Request (SRQ) bus control line true. The instrument can send the Require Service message in either local or remote mode. The Require Service message is cleared when a serial poll is executed by the controller or if a Clear message is received by the Distortion Analyzer. (During serial poll, the Require Service message is cleared immediately before the Distortion Analyzer places the Status Byte message on the bus.) An HP-IB code error will always cause a Require Service message to be issued. In addition, there are two other conditions which can be enabled to cause the Require Service message to be sent when they occur. All three conditions are described as follows.



- **Data Ready:** When the Distortion Analyzer is ready to send any information except error codes or the Status Byte.
- **HP-IB Code Error:** When the Distortion Analyzer receives an invalid Data message. (This condition always causes a Require Service message to be sent.)

#### NOTE

*The "----" display indicates a transient condition. After nine attempts to make a measurement, it is replaced by Error 31 which causes the Require Service message to be sent.*

- **Instrument Error:** When any Error is being displayed by the Distortion Analyzer including HP-IB Code error, Error 24.

### 3-28. Selecting the Service Request Condition

Use Special Function 22, Service Request Condition, to enable the Distortion Analyzer to issue the Require Service message on any of the conditions above (except HP-IB code errors which always cause the Require Service message to be sent). The Service Request Condition Special Function is entered from HP-IB. The conditions enabled by Special Function 22 are always disabled by the Clear message. A description of the Service Request Condition Special Function and the procedure for enabling the various conditions are given under *Service Request Condition* in the *Detailed Operation Instructions*. Normally, device subroutines for the Distortion Analyzer can be implemented simply by triggering measurements then reading the output data. In certain applications, the controller must perform other tasks while controlling the Distortion Analyzer. Figure 3-7 illustrates a flow chart for developing device subroutines using the instrument's ability to issue the Require Service message when data is ready. This sub-routine structure frees the controller to process other routines until the Distortion Analyzer is ready with data.

### 3-29. Sending the Status Byte Message

The Status Byte message consists of one 8-bit byte in which 3 of the bits are set according to the enabled conditions described above under Sending the Require

Service Message. If one or more of the three conditions described above are both enabled and present, all the bits corresponding to the conditions and also bit 7, the RQS bit, will be set true (and the Require Service message is sent). If one of the above conditions occurs but has not been enabled by Special Function 22, neither the bit corresponding to the condition nor the RQS bit will be set (and the Require Service message will not be sent). The bit pattern of the Status Byte is shown in the table labeled "Status Byte:", on the following pages.

Once the Distortion Analyzer receives the serial poll enable bus command (SPE), it is no longer allowed to alter the Status Byte. When addressed to talk (following SPE), the Distortion Analyzer sends the Status Byte message.

#### NOTE

*Since the Distortion Analyzer cannot alter the Status Byte while in serial poll mode, it is not possible to continually request the Status Byte while waiting for a condition to cause a bit to be set.*

After the Status Byte message has been sent it will be cleared if the Serial Poll Disable (SPD) bus command is received, if the Abort message is received, or if the Distortion Analyzer is unaddressed to talk. Regardless of whether or not the Status Byte message has been sent, the Status Byte and any Require Service message pending will be cleared if a Clear message is received. If the instrument is set to Talk Only, the Status Byte is cleared each time the one-byte Data message is issued to the bus.

### 3-30. Sending the Status Bit Message

The Distortion Analyzer does not respond to a Parallel Poll Enable (PPE) bus command, and thus cannot send the Status Bit Message.

### 3-31. Receiving the Abort Message

The Abort Message is the means by which the controller sets the Interface Clear (IFC) bus control line true. When the Abort message is received, the Distortion Analyzer becomes unaddressed and stops talking or listening.

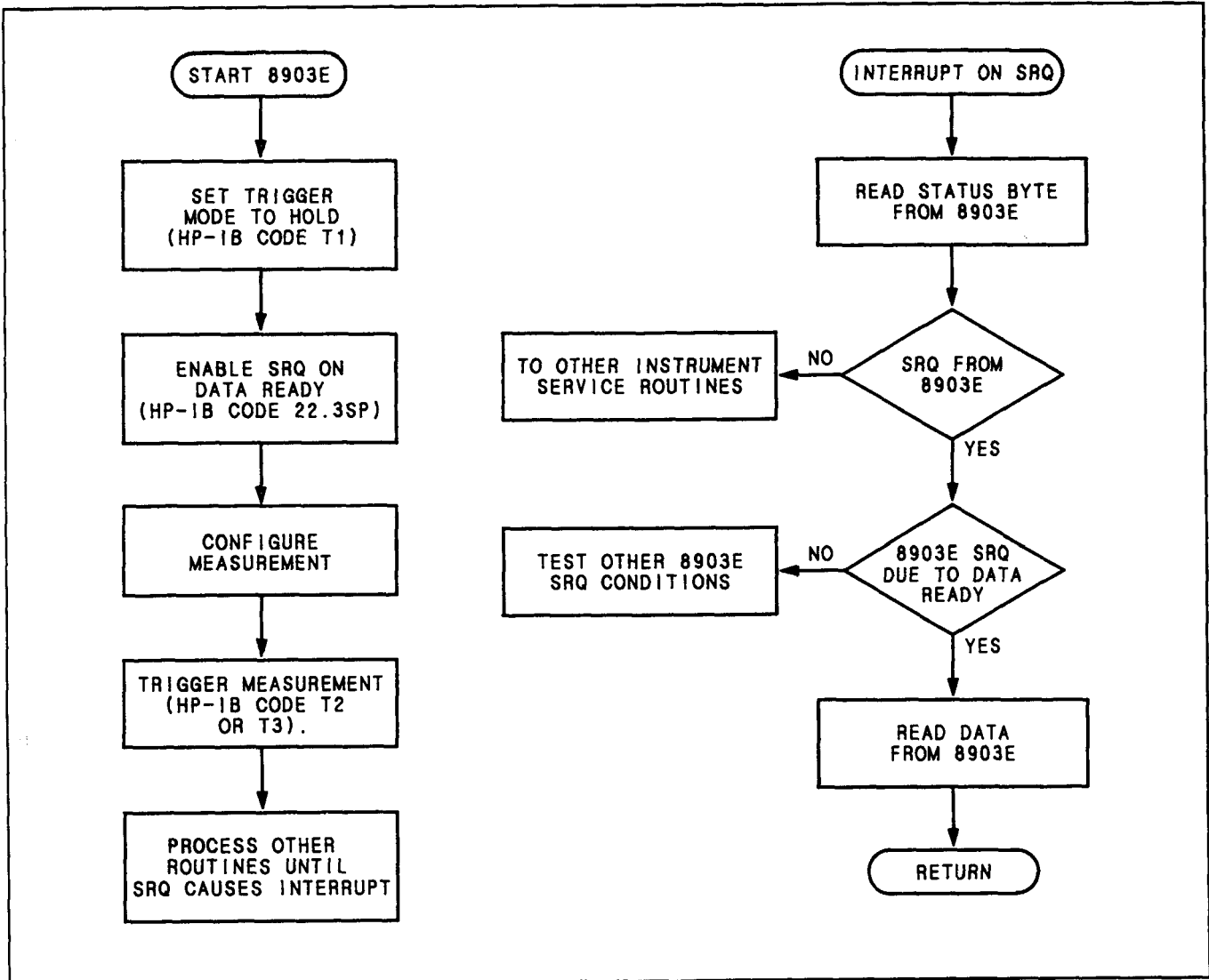

Figure 3-4. Example Flow Chart for Driving the Distortion Analyzer Using the Require Service Message (SRQ)



### HP-IB SYNTAX AND CHARACTERISTICS SUMMARY

#### Address:

Set in binary by internal switches — may be displayed on front panel using S (Shift) LCL. Factory set to 28 decimal.

#### General Operating Syntax: (Excluding Rapid Frequency Count modes.)\*

[Automatic Operation] [Measurement] [Filters] [Special Functions] [Log/Lin] [Ratio]

#### Numeric Data Input Format: (Except in Rapid Source mode.)\*

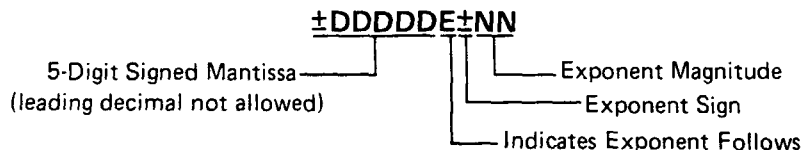

#### Output Formats: (Except in Rapid Frequency Count mode.)\*

Data (valid data output value always  $<4 \times 10^9$  and in fundamental units):

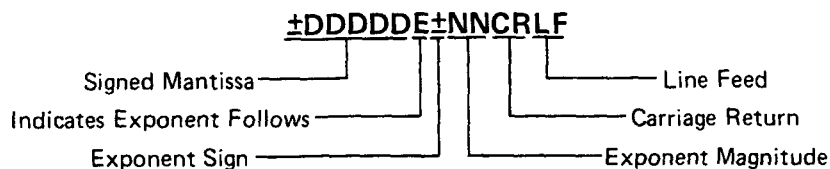

#### Errors:

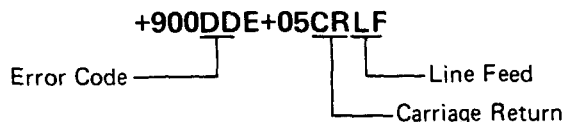

#### Return to Local:

Front panel LCL key if not locked out.

#### Manual Trigger:

Front panel S (Shift) AVG/RMS (the Clear Key Function) keys initiate Trigger with Settling measurement.

#### Status Byte:

Bit	8	7	6	5	4	3	2	1
Weight	128	64	32	16	8	4	2	1
Service Request Condition	0 (always)	RQS Bit Require Service	0 (always)	0 (always)	0 (always)	Instrument Error	HP-IB Code Error	Data Ready

Notes:

1. The condition indicated in bits 1 and 3 must be enabled to cause a Service Request by Special Function 22, Service Request Condition.
2. The RQS bit (bit 7) is set true whenever an HP-IB code error occurs or when any of the conditions of bits 1 and 3 are enabled and occur.
3. Bits set remain set until the Status Byte is cleared.

**Complete HP-IB Capability** (as described in IEEE Std 488, and ANSI Std MC1.1): SH1, AH1, T5, TE0, L3, LE0, SR1, RL1, PP0, DC1, DT1, C0, E1.

\* For information on Rapid Frequency Count mode refer to it by name in the *Detailed Operating Instructions*.





Table 3-6. Distortion Analyzer Parameter to HP-IB Code Summary

Parameter	Program Code	Parameter	Program Code
Automatic Operation	AU	Ratio	
SPCL	SP	On	R1
SPCL SPCL	SS	Off	R0
Measurements		Log/Lin	
AC Level	M1	Log	LG
SINAD	M2	Lin	LN
Distortion	M3	Trigger Modes	
DC Level	S1	Free Run	T0
Distortion Level	S3	Hold	T1
RMS Detector	A0	Trigger Immediate	T2
AVG Detector	A1	Trigger with Settling	T3
Automatic Notch Tuning	N0	Miscellaneous	
Notch Hold	N1	Read Left Display	RL
Internal Plug-in HP/BP Filters		Read Right Display	RR
Left Plug-in Filter on	H1	Rapid Frequency Count	RF
Right Plug-in Filter on	H2	Clear Key Function*	CL
All Plug-in HP/BP Filters off	H0		
LP Filters			
30 kHz LP Filter on	L1		
80 kHz LP Filter on	L2		
All LP Filters off	L0		

\*Not to be confused with Clear message which is defined in Table 3.

Table 3-7. Audio Analyzer HP-IB Code to Parameter Summary

Program Code	Parameter	Program Code	Parameter
A0	RMS Detector	RF	Rapid Frequency Count
A1	AVG Detector	RL	Read Left Display
AU	Automatic Operation	RR	Read Right Display
CL	Clear Key Function*	R0	Ratio on
H0	All Internal Plug-in HP/BP Filters off	R1	Ratio off
H1	Left Plug-in Filter on	SP	SPCL
H2	Right Plug-in Filter on	SS	SPCL SPCL
LG	Log	S1	DC Level
LN	Linear	S3	Distortion Level
L0	All LP Filters off	T0	Free Run
L1	30 kHz LP Filter on	T1	Hold
L2	80 kHz LP Filter on	T2	Trigger Immediate
M1	AC Level	T3	Trigger with Settling
M2	SINAD	-	- (minus)
M3	Distortion	0—9	0—9
N0	Automatic Notch Tuning	.	. (decimal point)
N1	Notch Hold		

\*Not to be confused with Clear message which is defined in Table 3-3.



Table 3-8. Distortion Analyzer Special Function to HP-IB Code Summary

Special Function	Program Code	Special Function	Program Code
Input Level Range (except DC Level)		Error Disable	
Automatic Selection	1.0SP	All errors enabled	8.0SP
300V range	1.1SP	Disabled Analyzer errors	8.1SP or
189V range	1.2SP	(Errors 12-17,31, and 96)	8.3SP
119V range	1.3SP	Disable External Source errors	8.2SP*
75.4V range	1.4SP	(Error 19)	*(This code is ignored)
47.6V range	1.5SP		
30.0V range	1.6SP	Hold Settings	
18.9V range	1.7SP	Hold input level ranges,	
11.9V range	1.8SP	post-notch gain, decimal	
7.54V range	1.9SP	point and notch tuning	
4.76V range	1.10SP	at present settings.	9.0SP
3.00V range	1.11SP		
1.89V range	1.12SP	Re-enter Ratio Mode	
1.19V range	1.13SP	Restore last RATIO reference	
0.754V range	1.14SP	and enter RATIO mode if allowed.	11.0SP
0.476V range	1.15SP	Display RATIO reference.	11.1SP
0.300V range	1.16SP		
0.189V range	1.17SP	Time Between Measurements	
0.119VV range	1.18SP	Minimum time between	
0.0754V range	1.19SP	measurements	14.0SP
Input Level Range (DC Level only)		Add 1s between measurements	14.1SP
Automatic Selection	2.0SP		
300V range	2.1SP	SINAD Display Resolution	
64V range	2.2SP	0.01 dB above 25 dB;	16.0SP
16V range	2.3SP	0.5 dB below 25 dB	
4V range	2.4SP	0.01 dB all ranges	16.1SP
Post Notch Gain			
Automatic Selection	3.0SP	Display Level in Watts	
0 dB gain	3.1SP	Display level as watts into 8Ω.	19.0SP
20 dB gain	3.2SP	Display level as watts into NNNΩ.	19.NNNSP
40 dB gain	3.3SP		
60 dB gain	3.4SP	Read Display to HP-IB.	
Hold Decimal Point		Read right display.	20.0SP
Automatic Selection	4.0SP	Read left display.	20.1SP
DDDD. range	4.1SP		21.0SP
DDD.D range	4.2SP	HP-IB Address	
DD.DD range	4.3SP	Displays HP-IB address (in binary)	
D.DDD range	4.4SP	in left display; right display	
0.DDDD range	4.5SP	in form TLS where T=1	
DD.DD mV range	4.6SP	means talk only; L=1 means	
D.DDD mV range	4.7SP	listen only; S=1 means SRQ.	
0.DDDD mV range	4.8SP	Displays HP-IB address in decimal.	21.1SP
Post Notch Detector Response		HP-IB Service Request Condition	22.NSP
(except in SINAD)		Enable a Condition to cause a	
Fast RMS Detector	5.0SP	service request, N is the sum	
Slow RMS Detector	5.1SP	of any combination of the	
Fast AVG Detector	5.2SP	weighted conditions below:	
Slow AVG Detector	5.3SP	1—Data Ready	
Notch Tune		2—HP-IB error	
Automatic notch tuning	6.0SP	4—Instrument error	
Hold notch tuning	6.1SP	The instrument powers up in	
		the 22.2 state (HP-IB error).	



Table 3-9. Commonly-Used Code Conversions

ASCII	Binary	Octal	Decimal	Hexa-decimal	ASCII	Binary	Octal	Decimal	Hexa-decimal
NUL	00 000 000	000	0	00	@	01 000 000	100	64	40
SOH	00 000 001	001	1	01	A	01 000 001	101	65	41
STX	00 000 010	002	2	02	B	01 000 010	102	66	42
ETX	00 000 011	003	3	03	C	01 000 011	103	67	43
EOT	00 000 100	004	4	04	D	01 000 100	104	68	44
ENQ	00 000 101	005	5	05	E	01 000 101	105	69	45
ACK	00 000 110	006	6	06	F	01 000 110	106	70	46
BEL	00 000 111	007	7	07	G	01 000 111	107	71	47
BS	00 001 000	010	8	08	H	01 001 000	110	72	48
HT	00 001 001	011	9	09	I	01 001 001	111	73	49
LF	00 001 010	012	10	0A	J	01 001 010	112	74	4A
VT	00 001 011	013	11	0B	K	01 001 011	113	75	4B
FF	00 001 100	014	12	0C	L	01 001 100	114	76	4C
CR	00 001 101	015	13	0D	M	01 001 101	115	77	4D
SO	00 001 110	016	14	0E	N	01 001 110	116	78	4E
SI	00 001 111	017	15	0F	O	01 001 111	117	79	4F
DLE	00 010 000	020	16	10	P	01 010 000	120	80	50
DC1	00 010 001	021	17	11	Q	01 010 001	121	81	51
DC2	00 010 010	022	18	12	R	01 010 010	122	82	52
DC3	00 010 011	023	19	13	S	01 010 011	123	83	53
DC4	00 010 100	024	20	14	T	01 010 100	124	84	54
NAK	00 010 101	025	21	15	U	01 010 101	125	85	55
SYN	00 010 110	026	22	16	V	01 010 110	126	86	56
ETB	00 010 111	027	23	17	W	01 010 111	127	87	57
CAN	00 011 000	030	24	18	X	01 011 000	130	88	58
EM	00 011 001	031	25	19	Y	01 011 001	131	89	59
SUB	00 011 010	032	26	1A	Z	01 011 010	132	90	5A
ESC	00 011 011	033	27	1B	[	01 011 011	133	91	5B
FS	00 011 100	034	28	1C	\	01 011 100	134	92	5C
GS	00 011 101	035	29	1D	]	01 011 101	135	93	5D
RS	00 011 110	036	30	1E	^	01 011 110	136	94	5E
US	00 011 111	037	31	1F	_	01 011 111	137	95	5F
SP	00 100 000	040	32	20	`	01 100 000	140	96	60
!	00 100 001	041	33	21	a	01 100 001	141	97	61
"	00 100 010	042	34	22	b	01 100 010	142	98	62
#	00 100 011	043	35	23	c	01 100 011	143	99	63
\$	00 100 100	044	36	24	d	01 100 100	144	100	64
%	00 100 101	045	37	25	e	01 100 101	145	101	65
&	00 100 110	046	38	26	f	01 100 110	146	102	66
'	00 100 111	047	39	27	g	01 100 111	147	103	67
(	00 101 000	050	40	28	h	01 101 000	150	104	68
)	00 101 001	051	41	29	i	01 101 001	151	105	69
*	00 101 010	052	42	2A	j	01 101 010	152	106	6A
+	00 101 011	053	43	2B	k	01 101 011	153	107	6B
,	00 101 100	054	44	2C	l	01 101 100	154	108	6C
-	00 101 101	055	45	2D	m	01 101 101	155	109	6D
.	00 101 110	056	46	2E	n	01 101 110	156	110	6E
/	00 101 111	057	47	2F	o	01 101 111	157	111	6F
0	00 110 000	060	48	30	p	01 110 000	160	112	70
1	00 110 001	061	49	31	q	01 110 001	161	113	71
2	00 110 010	062	50	32	r	01 110 010	162	114	72
3	00 110 011	063	51	33	s	01 110 011	163	115	73
4	00 110 100	064	52	34	t	01 110 100	164	116	74
5	00 110 101	065	53	35	u	01 110 101	165	117	75
6	00 110 110	066	54	36	v	01 110 110	166	118	76
7	00 110 111	067	55	37	w	01 110 111	167	119	77
8	00 111 000	070	56	38	x	01 111 000	170	120	78
9	00 111 001	071	57	39	y	01 111 001	171	121	79
:	00 111 010	072	58	3A	z	01 111 010	172	122	7A
;	00 111 011	073	59	3B	{	01 111 011	173	123	7B
<	00 111 100	074	60	3C		01 111 100	174	124	7C
=	00 111 101	075	61	3D	}	01 111 101	175	125	7D
>	00 111 110	076	62	3E	~	01 111 110	176	126	7E
?	00 111 111	077	63	3F	DEL	01 111 111	177	127	7F

# AC Level

## Description

The Distortion Analyzer contains a wideband, true rms or average-responding voltmeter with high accuracy and sensitivity. Pressing the AC LEVEL key causes the Distortion Analyzer to measure the differential ac voltage between the center and outer conductor of the INPUT connector or, for Option 001 only, the center conductors of the (rear-panel) INPUT connectors. Signals common to both high and low inputs are rejected. See the following Warning and Caution.

### WARNING

*To avoid the possibility of hazardous shock on standard instruments (those without Option 001), do not apply more than 42V peak to the outer conductor of the BNC INPUT connector when the FLOAT switch is in the FLOAT position.*

### CAUTION



*Do not apply more than 300 Vrms (either differential, common-mode, or a combination) to the INPUT connector(s).*

## Procedure

To make an ac level measurement, press the AC LEVEL key. AC level results can be displayed in V, mV, dBm, watts, or as the ratio to an entered or measured value. The Distortion Analyzer powers up displaying ac level in linear units (mV or V). To obtain a display in dBm (that is, dB relative to 1 milliwatt into a 600-ohm load, equivalent to dBre 0.775V), press the LOG/LIN key. To return to linear, simply press the LOG/LIN key again. If the ac level is to be displayed relative to a reference, refer to Ratio and LOG/LIN.

## Example

To measure the ac level of a signal at the INPUT connector:

<p><b>LOCAL</b> (keystrokes)</p>	<p>Measurement</p> 
<p> (program codes)</p>	<p>M1 Measurement</p>

**Program Code** M1 is the program code for AC LEVEL.



## Indications

When ac level is selected, the LED within the AC LEVEL key will light. The right display shows the ac level with the appropriate units. The Distortion Analyzer automatically ranges for maximum resolution and accuracy. The left display shows the input signal frequency. If the input level to the frequency counter is too small, the left display will show 0.000 kHz. (This will often occur when the signal is in the stop band of the optional plug-in HP/BP filters, but not the low-pass filters.)

## Measurement Technique

In ac level the Distortion Analyzer acts as an ac voltmeter. The Distortion Analyzer automatically sets the input attenuation and the gain settings of the various amplifiers so that the input signal amplitude lies within the range of the output detector. The output

## AC Level (cont'd)

**Measurement Technique (cont'd)** detector converts the ac level to a dc voltage which is then measured by the dc voltmeter and after correction for input gain and attenuation, displayed in appropriate units. The frequency of the input signal is also measured and displayed.

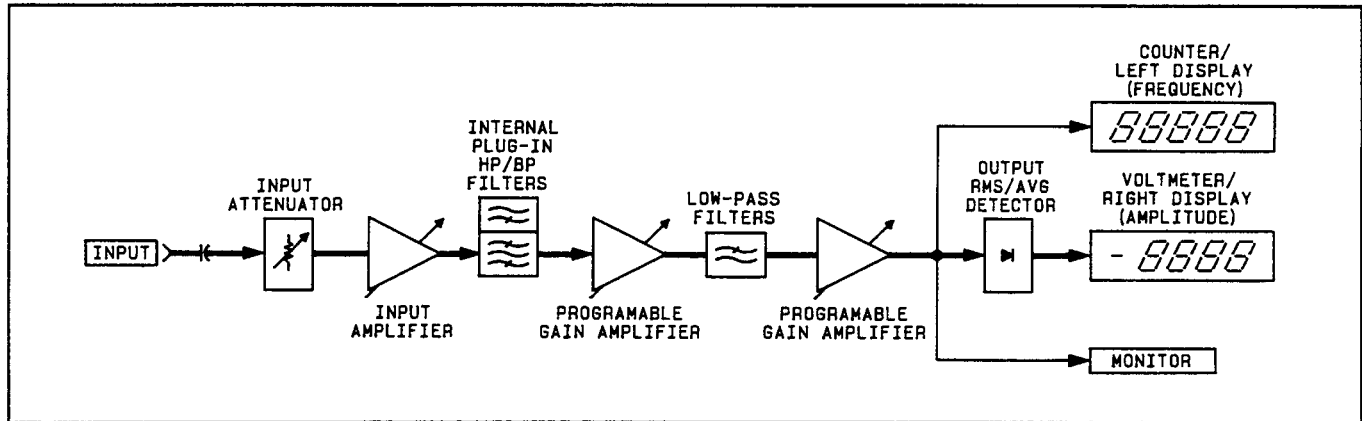

*AC Level Measurement Block Diagram*

**Comments** The Distortion Analyzer powers up in the ac level measurement mode with the 80 kHz low-pass filter activated. The 80 kHz low-pass filter reduces the measurement bandwidth from 750 kHz to 80 kHz.

Two ac level detectors are available: true rms and average-responding (but rms calibrated). See the section *Detector Selection* for details.

### Related Sections

Common Mode  
 Detector Selection  
 Display Level in Watts  
 Filters  
 Monitor  
 RATIO and LOG/LIN  
 Special Functions

# Automatic Operation

**Description** The Automatic Operation code sets the instrument functions to automatic (that is, each function is allowed to automatically range to the appropriate setting). It also cancels all of the special functions.

**Procedure** To set the Distortion Analyzer to automatic operation, you must use HP-IB.

**Example** To set the Distortion Analyzer to automatic operation:

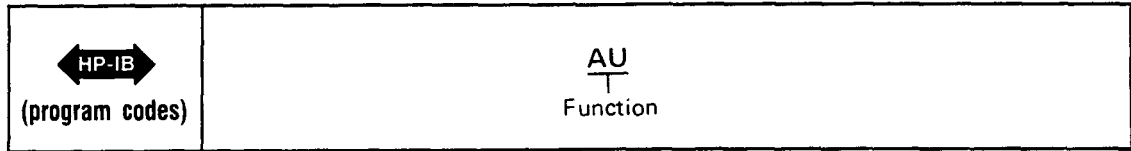

**Program Code** AU is the HP-IB code for Automatic Operation.

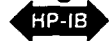

**Indications** When the HP-IB program code is entered, the left and right displays blank, the right display shows four dashes, then both displays show the current measurement mode and input.

**Comments** The converse of the automatic operation mode is the Hold Settings Special (prefixed 9). Refer to *Hold Settings*.

For information on which specific Special Functions are turned off by the Automatic Operation mode, refer to Special Functions. Since Automatic Operation affects Special Functions, it is a good practice to place the AU code at the beginning of a program string when programming the instrument.

**Related Sections** Hold Settings  
Special Functions

## Common Mode

### Description

Common-mode rejection ratio, or “common-mode” as it is usually referred to, is a measure of the ability of an amplifier to reject signals that are common to both amplifier inputs while allowing the differential signals (which may or may not be the weaker signal) to be amplified and passed on to the measurement circuitry.

Since the analyzer input is fully balanced, it can reject signals which are common to the High and Low Inputs (with the INPUT FLOAT switch in the FLOAT position). For standard instruments, the High Input is the center conductor of the INPUT BNC connector; the Low Input is its outer conductor. For instruments with Option 001, the High and Low Inputs are the center conductors of the respective HIGH and LOW INPUT connectors. However, for valid measurement results, there are limitations to the maximum level of common-mode signals.

### WARNING

*To avoid the possibility of hazardous shock on standard instruments (those without Option 001), do not apply more than 42V peak to the outer conductor of the BNC INPUT connector when the FLOAT switch is in the FLOAT position.*

### CAUTION

*Do not apply more than 300 Vrms (either differential, common-mode, or a combination) to the INPUT connector(s).*

Common-mode signal limitations exist because the instrument’s ranging detector (which determines the input voltage range), is designed to read only the *differential* signal (between the High and Low Inputs). Thus, the instrument can set an incorrect input range if a large common-mode signal is present. Erroneous measurements may be obtained as a result.

The Analyzer Input Block Diagram illustrates that the ranging detector senses the voltage difference between the High and Low Input lines. Common-mode signals are “ignored” by the ranging detector, while the differential signals are measured. The block diagram also illustrates that the High and Low Input lines have over-voltage protection circuits *that open when the input voltage (single or combined common-mode and differential) exceeds the maximum safe limit.*

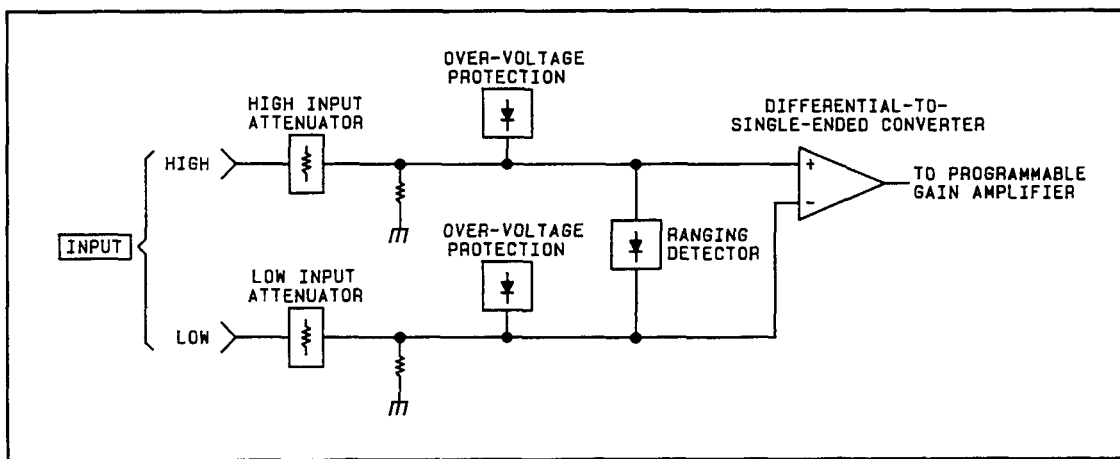

*Analyzer Input Block Diagram*

## Common Mode (cont'd)

### Example

If a common-mode signal of 10V is on the analyzer's input with a 1V differential signal, the ranging detector selects the 1.19V range. The signal that is present at the input is actually 11V (10V common-mode signal + the 1V differential signal). A voltage signal this large can exceed the input amplifiers' operating range and cause erroneous measurements. However, the instrument will not be damaged because the Over-voltage Protection circuitry will open whenever the combined common-mode and differential signals exceed the instrument's safe operating range. (Setting Special Function 1.8 will set the input range to 11.9V.)

### Comments

For error-free measurements, the Operating Region For Valid Measurements graphs, shown below, indicate the maximum allowable common-mode input voltages for a given differential input voltage. Case 1 is for a single-ended source with a common-mode signal present on both input lines. Case 2 is for a balanced source with common-mode signals on both input lines.

To obtain the maximum common-mode input voltage level from the graphs, select the desired value for the differential input voltage. Then read the common-mode input voltage level.

For example, on the Case 1 graph, for a differential input voltage level of 1V, the maximum common-mode input voltage level is 2.8V. For a differential input voltage of 20V, the maximum common-mode input level is 20V.

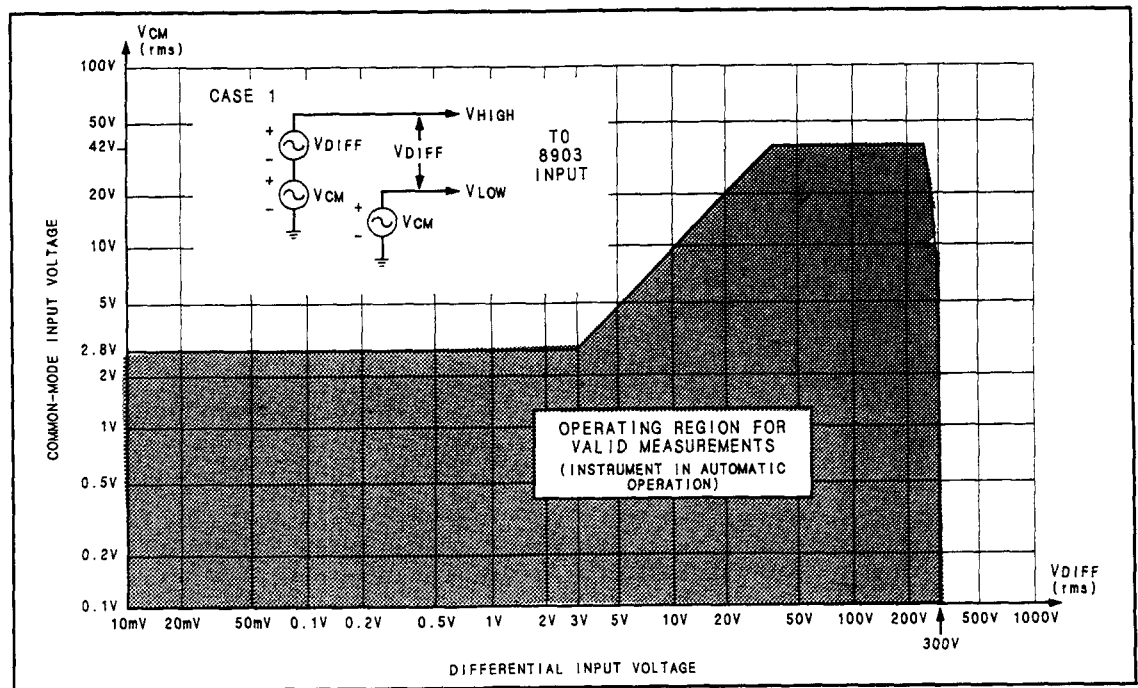

CASE 1. Single-Ended Source with Common Mode on Both Lines



# Common Mode (cont'd)

**Comments (cont'd)**

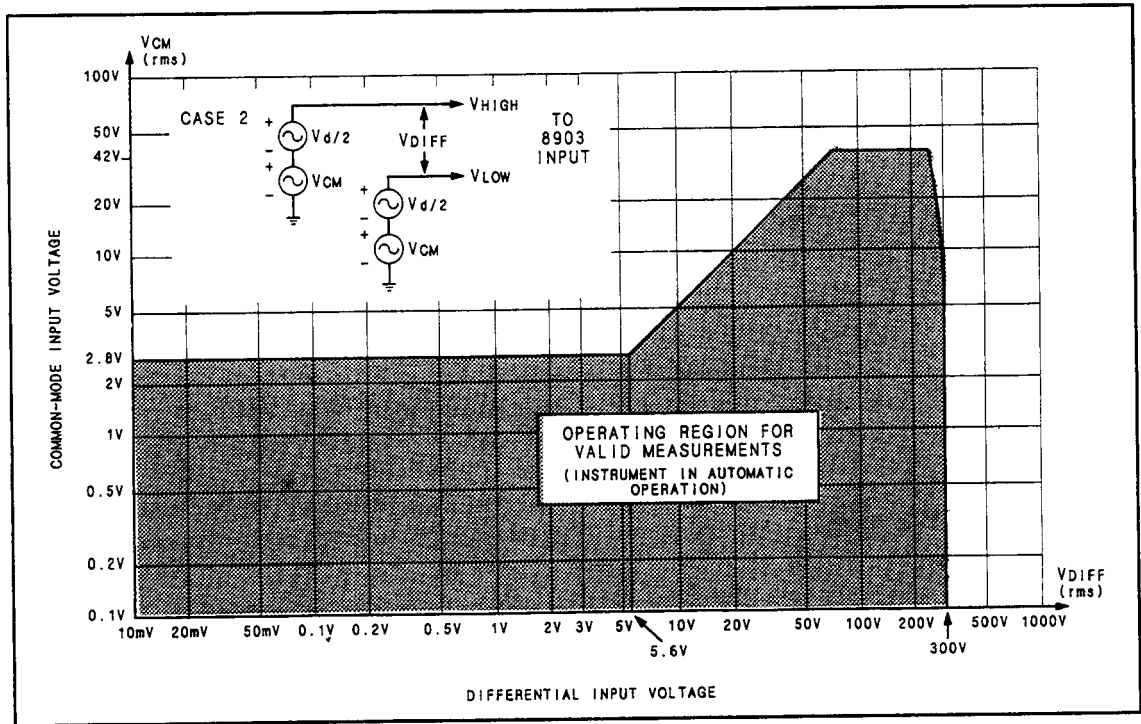

CASE 2. Balanced Source with Common Mode on Both Sides

**Related Sections**

- AC Level
- DC Level

# DC Level

**Description** Pressing the DC LEVEL key causes the Distortion Analyzer to measure the differential dc voltage between the center and outer conductor of the INPUT connector or, for Option 001 only, the center conductors of the (rear-panel) INPUT connectors. Voltage common to both high and low inputs are rejected. See the following Warning and Caution.

**WARNING**



*To avoid the possibility of hazardous shock on standard instruments (those without Option 001), do not apply more than 42V peak to the outer conductor of the BNC INPUT connector when the FLOAT switch is in the FLOAT position.*

**CAUTION**

*Do not apply more than 300 Vrms (either differential, common-mode, or a combination) to the INPUT connector(s).*

**Procedure** To make a dc level measurement, press the S (Shift) key, then the DC LEVEL key. The voltage can be expressed in either volts, or, if the voltage is positive, in dBm (that is, dB relative to 1 milliwatt into 600Ω). To obtain a display in dBm, press the LOG/LIN key. To return to linear, simply press the LOG/LIN again. If the dc level is to be displayed relative to a reference level, refer to RATIO and LOG/LIN.

**Example** To measure the dc level at the INPUT connector:

<b>LOCAL</b> (keystrokes)	
 (program codes)	<b>S1</b> Measurement

**Program Code** S1 is the HP-IB code for DC LEVEL.



**Indications** When dc level is selected, the LEDs within the DC LEVEL key and the S (Shift) key will light. The right display shows the dc level with the appropriate units. The Distortion Analyzer automatically ranges for maximum resolution and accuracy. In the dc level measurement mode, the left display is blanked even though an ac signal may be present.

**Measurement Technique** In the dc level measurement mode the Distortion Analyzer automatically sets the input attenuation and the gain of the input amplifier so that the signal amplitude lies within the proper range of the dc voltmeter. The signal is then measured by the dc voltmeter and after correction for input gain and attenuation, displayed in appropriate units.

**Comments** In the dc level measurement mode only the ac component of the input signal is coupled to the MONITOR output. The ac component also affects the input gain.

**Related Sections**  
 Common Mode  
 RATIO and LOG/LIN  
 Special Functions

## Default Conditions and Power-up Sequence

### Description

When first turned on, the Distortion Analyzer performs a sequence of internal checks after which the instrument is ready to make measurements. During the power-up sequence, all front-panel indicators light to allow the operator to determine if any are defective. After approximately four seconds, this sequence is completed and the Distortion Analyzer is preset as follows:

MEASUREMENT .....	AC LEVEL
DETECTOR .....	RMS
LP FILTER .....	LOW PASS 80 kHz
HP/Weighting BP Filter .....	Off
RATIO .....	Off
Ratio Reference .....	0
LOG/LIN .....	LIN (see <i>RATIO</i> and <i>LOG/LIN</i> Detailed Operating Instruction)
Left Display .....	Input Frequency
Right Display .....	Input AC Level
Service Request Condition .....	HP-IB Code Error Only
Status Byte .....	Cleared
Trigger Mode .....	Free Run (Code T0)
Special Functions .....	All Special Functions off or in their zero suffix, except Service Request Condition which is set to 22.2 (HP-IB Code Error).

### NOTE

*The FLOAT switch is set manually.*

### Related Sections

Ratio and LOG/LIN  
Service Request Condition

# Detector Selection

## (Special Function 5)

**Description** The Distortion Analyzer contains a wideband, true rms or average-responding voltmeter with high accuracy and sensitivity. The Distortion Analyzer can be switched to have either a true rms or averaging detector response.

**Procedure** To select the AVG Detector, press the AVG/RMS key. The key light will light to indicate average detection. To select the RMS Detector, press the AVG/RMS key again. The key light will extinguish, indicating true rms detection.

**Example**

Detector	Program Code
	
rms	A0 or 5.0SP
average	A1 or 5.2SP

**Program Code** Code A0 is the HP-IB code for RMS Detector. A1 is the HP-IB code for AVG Detector.



For fast or slow detection selection (either rms or average), enter the following HP-IB codes: 5.0SP for fast rms detection, or 5.1SP for slow rms detection. For average detection, enter the following HP-IB codes: 5.2SP for fast average detection, or 5.3SP for slow average detection.

**Indications** When 5.0SP or 5.1SP is entered, the light in the AVG/RMS key will go out if it is on. When 5.2SP or 5.3SP is entered, the light in the AVG/RMS key will light indicating average detection has been selected.

**Measurement Technique** When measuring complex waveforms or noise, a true rms detector will provide a more accurate rms measurement than an average-responding detector which has been calibrated to indicate the rms value of a sine wave. For a sine wave, both the true rms and the average-responding detectors give correct rms readings. However, when the signal is a complex waveform, or when significant noise is present, the average-responding detector reading can be in error. The amount of error depends upon the particular signal being measured. For noise, an average-responding detector reads low.

**Comments** Many ac voltmeters employ an average-responding detector. For those applications requiring the use of an average-responding detector, press the AVG/RMS key for average detection.

**Related Sections**

- AC Level
- Distortion
- Distortion Level
- SINAD

## Display Level in Watts (Special Function 19)

**Description** The measurement mode can be set to read the ac input power level in watts into a specified external load resistance by using Special Function 19 through HP-IB. The range of the selectable load resistance (in ohms) is an integer value from 1 to 999.

**Procedure** To set the measurement to display the ac level in watts into a specified resistance, enter the corresponding HP-IB code.

Resistance ( $\Omega$ )	Program Code ◀ HP-IB ▶
8	19.0SP
1-999	19.NNNSP (where NNN corresponds to the load resistance in ohms.)

**Example** To set the right display to read INPUT signal level in watts into an external 16 $\Omega$  speaker:

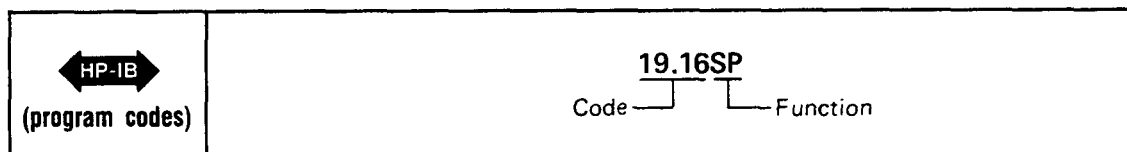

**Program Code** For HP-IB codes, refer to *Procedure* above.



**Indications** The right display shows a four-digit readout of the ac power in watts but no units are indicated. All measurement LEDs go off.

**Comments** The load resistance in ohms must be an integer (for example, a resistance of 5.8 $\Omega$  cannot be entered). The decimal point has already been used when entering the Special Function. An attempt to enter a second decimal point is ignored.

Remember that the instrument assumes that the input voltage is being developed across the specified external load resistance. If an incorrect resistance is entered, the readout in watts is shown for the resistance entered.

Zeros immediately following the decimal point are optional. For example, when setting the load resistance to 1 ohm, 19.1 is equivalent to 19.01 and 19.001. However, 19.1 is not equivalent to 19.10 or 19.100. Note that 19., 19.0, and 19.8 are equivalent (that is, they both specify an 8 $\Omega$  load resistance).

The displayed power level is accurate regardless of distortion unless the Distortion Analyzer's audio detector is set to average responding.

Neither the **RATIO** nor the **LOG** function can be used with this Special Function.

**Related Sections** AC level  
Detector Selection

# Distortion

**Description** The Distortion Analyzer measures distortion by first determining the following value:

$$D = \frac{\text{noise} + \text{distortion}}{\text{signal} + \text{noise} + \text{distortion}}$$

It then converts D into the appropriate measurement units as follows:

$$\% \text{ units} = D \times 100\%$$

$$\text{dB units} = 20\log D$$

The **RATIO** key can be used to compare the measured results to a predetermined ratio reference value (refer to *RATIO and LOG/LIN*).

A distortion measurement can be made on signals from 20 Hz to 100 kHz and from 50 mV to 300V in the single-ended mode (FLOAT switch in the grounded position).

**Procedure** To make a distortion measurement, press the **DISTN** key. Use the filters to limit noise, hum, spurious signals, etc. The Distortion Analyzer powers up with the LOW PASS 80 kHz filter activated.

**Example** To measure the distortion of an external source in a 30 kHz bandwidth:

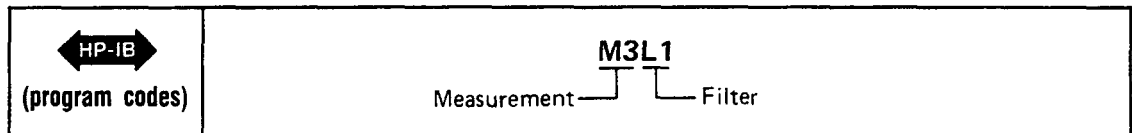

**Program Code** M3 is the HP-IB code for the distortion measurement.

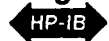

**Indications** When distortion is selected, the LED within the **DISTN** key will light. The frequency and distortion of the input signal are displayed, and the appropriate annunciators are lighted (see *Description* above).

**Measurement Technique** In the distortion measurement mode, the controller automatically sets the input attenuation and the gain settings of various amplifiers. This is accomplished by measuring the input signal with the ranging rms detector. This control ensures that the signal amplitude is within the proper range for the input and output detectors. The Input RMS/AVG Detector converts the ac level of the combined signal + noise + distortion to dc. The notch filter removes the fundamental signal. The notch filter automatically tunes to the component whose frequency is measured by the counter (usually the fundamental of the input signal). The output detector converts the residual noise + distortion to dc. The dc voltmeter measures both dc signals. The controller then corrects for the programmed gain and attenuation, computes the ratio of the two signals, and displays the results in appropriate units. The frequency of the input signal is also measured and displayed.

(Distortion Measurement Block Diagram on next page)

## Distortion (cont'd)

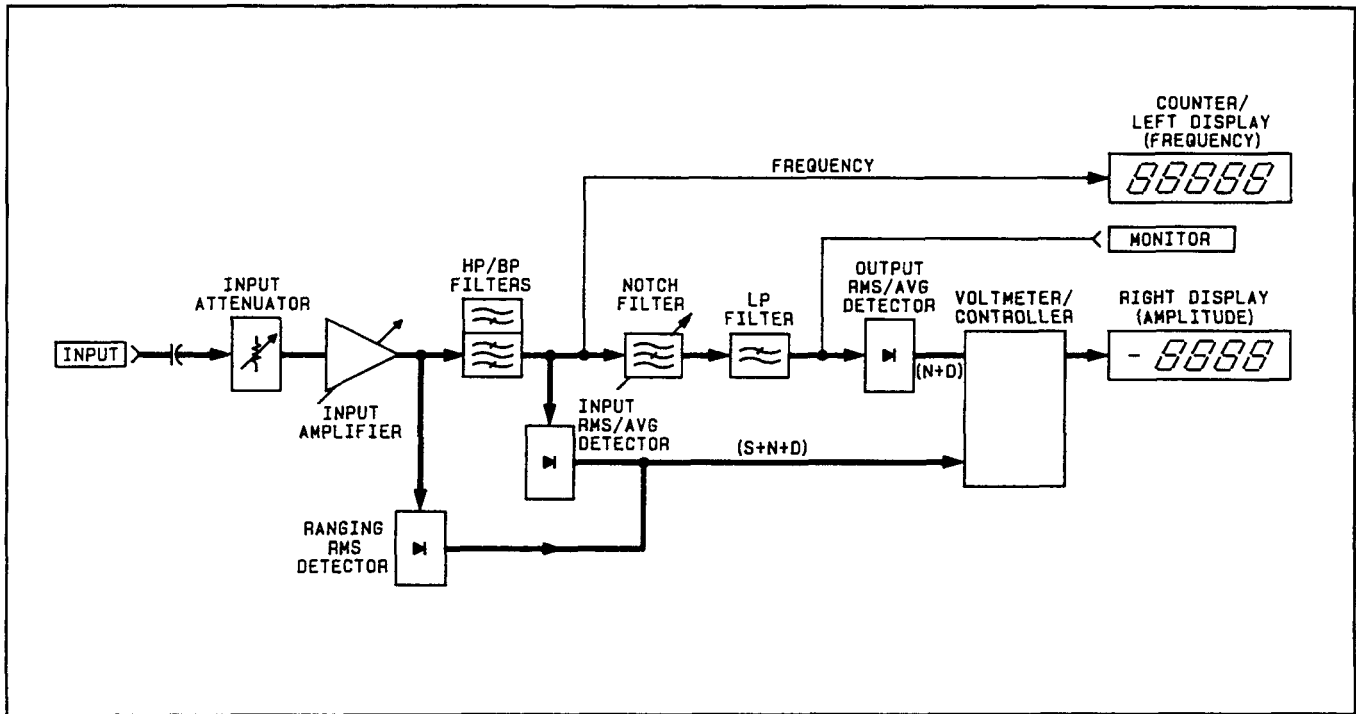

*Distortion Measurement Block Diagram*

**Comments** Distortion can be measured with either the true rms or average-responding detector. Most applications specify true rms detection.

**Related Sections**

- Detector Selection
- Distortion Level
- Filters
- Notch Tune
- RATIO and LOG/LIN

## Distortion Level

**Description** This measurement mode can be accessed only via HP-IB. The Distortion Analyzer measures the distortion level by removing the fundamental of the input signal and then measuring the ac level of the remaining noise and distortion. The mV and V units are displayed in the linear mode or the values are converted to dBm (that is, dB relative to 1 milliwatt into a 600Ω load). The **RATIO** key can be used to compare the measured results to a predetermined ratio reference (refer to *RATIO and LOG/LIN*).

**Procedure** To make a distortion level measurement, you must use the HP-IB Distortion Level program code S3. The filters are used to limit the bandwidth. The Distortion Analyzer powers up with the LOW-PASS 80 kHz filter activated.

**Example** To measure distortion level on an external source signal in a 30 kHz bandwidth:

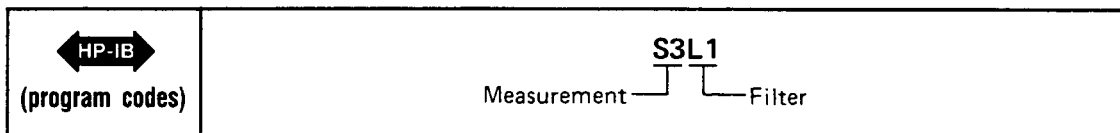

**Program Code** S3 is the HP-IB code for distortion level.



**Indications** When distortion level is selected, the frequency and amplitude of the input signal are displayed, and the appropriate annunciators and **DISTN** key light will light (see *Description* above).

**Measurement Technique** In the distortion level measurement mode, the controller automatically sets the input attenuation and the gain settings of various amplifiers. This control ensures that the signal amplitude is within the proper range for the output detector. The notch filter removes the fundamental from the input signal. The notch filter automatically tunes to the component whose frequency is measured by the counter (usually the fundamental of the input signal). The output detector converts the residual noise + distortion to dc. The dc voltmeter measures the signal, and the controller corrects for the programmed gain and attenuation. The results are then displayed in the appropriate units. The frequency of the input is also measured and displayed.

*(Distortion Level Measurement Block Diagram on next page)*



## Distortion Level (cont'd)

**Measurement  
Technique  
(cont'd)**

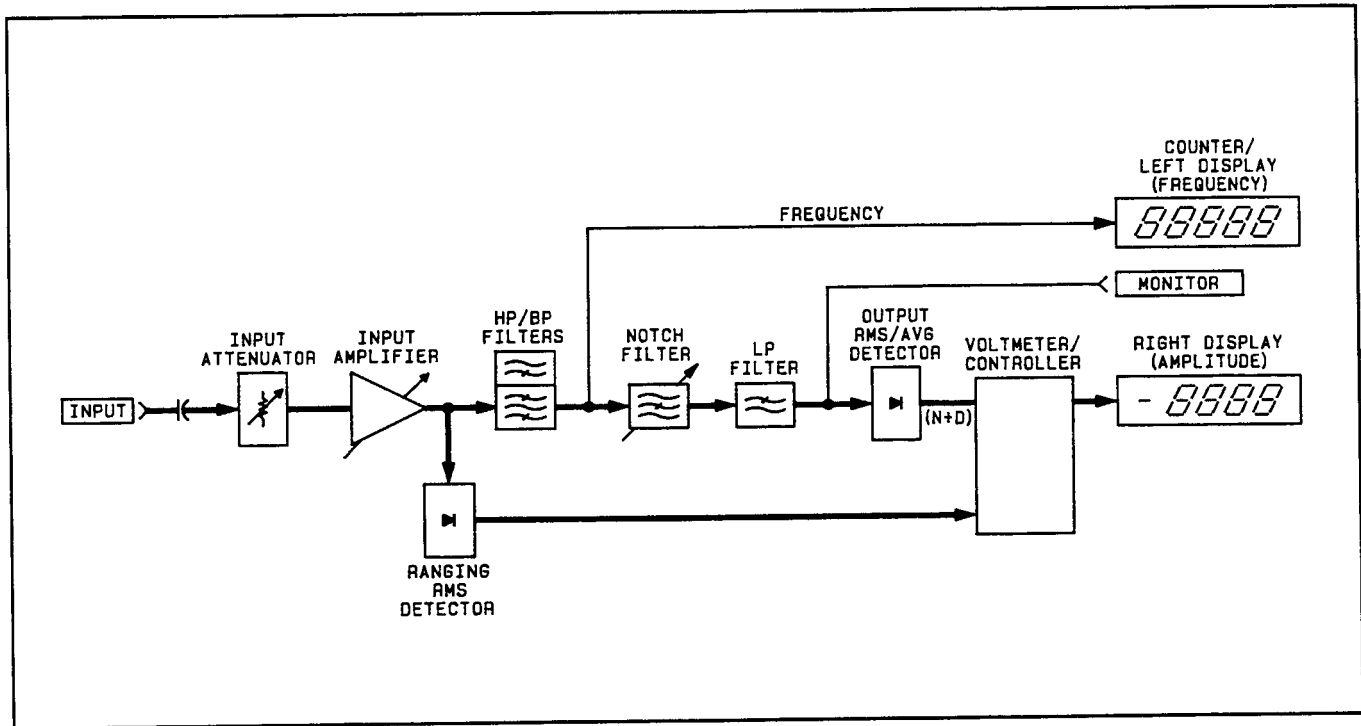

*Distortion Level Measurement Block Diagram*

**Related  
Sections**

- Detector Selection
- Distortion
- Filters
- Monitor
- Notch tune
- RATIO and LOG/LIN

# Error Disable

## (Special Function 8)

**Description** The Error Disable Function is used to selectively disable operating error messages. Using the 8.N Special Function allows the user to enable all operator error messages, or disable analyzer errors (measurement related errors).

**Procedure** To selectively disable (or enable) operator error messages, enter the corresponding HP-IB code.

Error Message Status	Program Code ◀ HP-IB ▶
All error messages enabled.	8.0SP
Disable analyzer error messages.	8.1SP or 8.3SP

**Example** To disable the analyzer error messages:

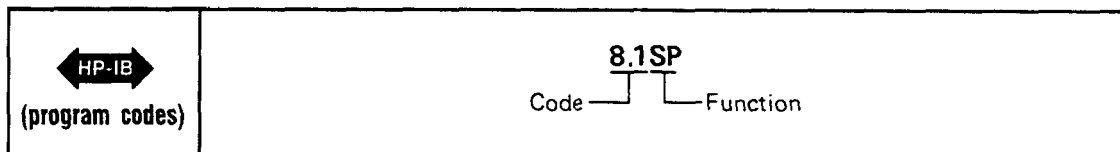

**Program Code** For HP-IB codes refer to *Procedure* above.



**Indications** As the program code is entered, both displays will blank, and the entered code will flash in the left display. Both displays return to the display that is appropriate for the currently selected measurement mode.

**Comments** HP-IB codes 8.1SP and 8.3SP perform the same function. HP-IB code 8.2SP can be entered over the bus, but is ignored.

The error messages can also be selectively disabled to prevent unwanted error interrupts to the HP-IB bus controller.

Error messages are one means by which the instrument safeguards accurate measurements. When these safeguards are disabled, erroneous measurements can result under certain conditions. This should be kept in mind when operating the instrument with error messages disabled.

**Related Sections**  
 Automatic Operation  
 Error Message Summary  
 Special Functions

# Error Message Summary

## Description

The instrument generates error messages to indicate operating problems, incorrect HP-IB entries, or service related problems. The error message is generally cleared when the error condition is removed. (Error 31 is an exception.) The Error Messages are grouped by error code as follows:

**Error 10 through Error 39 and Error 90 through Error 99.** These are Operating and Entry Errors that indicate that not all conditions have been met to assure a calibrated measurement, or that an invalid HP-IB code sequence entry has been made. The Error Disable Special Function (8.N) can be used to selectively disable certain operating error messages. Entry Errors require that a new program code entry be made.

**Error 65 through Error 89.** These are Service Errors that provide additional service related information. Service Errors must be enabled to appear and do not necessarily represent failures within the instrument. Service Errors are discussed in the Service Section (8) of this manual.

## HP-IB Output Format



The HP-IB output format for errors is shown below:

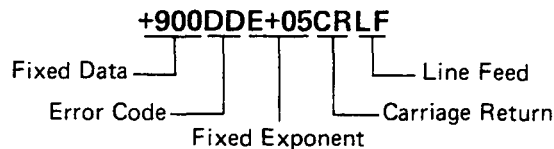

For example, Error 10 is output to the HP-IB as +90010E+05CRLF. This format differs from normal data outputs since normal data outputs will never exceed  $4 \times 10^9$ . Once an error has been input to the computing controller, the error code is simply derived by subtracting  $9 \times 10^9$  from the input number, then dividing the result by 100 000.

## Error Displays

Shown below and on the next page are three types of error displays. The first is typical of most error displays and is shown as a general case. The second and third have specific meaning and occur often.

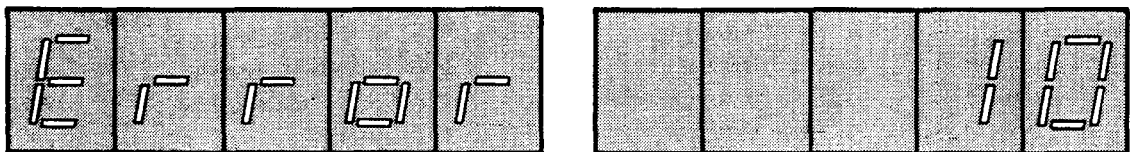

This display shows the general error display format. These errors are output to the HP-IB as shown under the HP-IB format above.

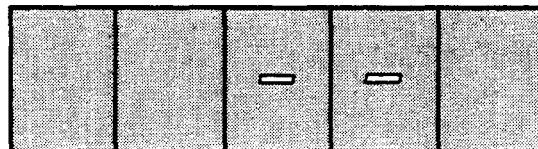

This display means that no signal has been sensed at the input. This display is output to the HP-IB as Error 96 using the HP-IB format shown above.

## Error Message Summary (cont'd)

**Error Displays (cont'd)**

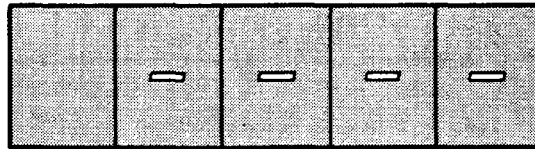

This display means that a signal has been detected, but for various reasons a measurement result is not yet available. This display is never output to the HP-IB and typically indicates a transitory state in instrument operation. After nine successive occurrences, the display changes to Error 31. Error 31 is output to the HP-IB using the HP-IB format shown above.

**Error Messages**

The table below describes all Operating and Entry errors. The error code, message, and the action typically required to remove the error-causing condition is given. Additional information pertaining to particular errors is also given.

Error Code	Message	Action Required/Comments
<b>Operating Errors</b>		
10	Reading too large for display.	This error code indicates that although the required calculation is within the capability of the instrument, the result of the calculation exceeds the display capabilities.
11	Calculated value out of range.	Enter new RATIO reference. Refer to <i>RATIO</i> and <i>LOG/LIN</i> .
13	Notch cannot tune to input.	Adjust input frequency to within specified limits. Refer to Table 1-1.
14	Input level exceeds instrument specifications.	This error code indicates that the input overload detector has tripped (not in range hold). This could be caused by too large an ac signal, or too much ac on a dc signal.
<b>NOTE</b>		
<i>Although error codes 17 and 19 are officially listed here under Operating Errors, they should be considered rather as diagnostic indications.</i>		
17	Internal voltmeter cannot make measurement.	This error code indicates that the counter has failed to return a value. This can only be caused by a malfunction in the counter. Refer to Service Sheet 14.
19	Cannot confirm external source frequency.	This error indicates that in notch routine, the frequency could not be measured, and thus the notch could not be adjusted. This usually indicates a counter problem. Refer to Service Sheet 14.
26	RATIO not allowed in present mode.	This error code indicates that use of the RATIO key does not make sense in the current mode. Refer to <i>RATIO</i> and <i>LOG/LIN</i> .

## Error Message Summary (cont'd)

**Error Messages (cont'd)**

Error Code	Message	Action Required/Comments
<b>Operating Errors (Cont'd)</b>		
30	Input overload detector tripped in range hold.	This error code indicates that the input signal is too high for the selected range. Use Special Function 1 to enter a more realistic range setting, or enter AU over the HP-IB to allow the Distortion Analyzer to seek the correct input range. Refer to <i>Automatic Operation</i> .
31	Cannot make measurement.	This error code indication occurs when the input signal is changing too quickly for the Distortion Analyzer to make consistent measurements or when the common mode signal is too large for the Distortion Analyzer. The "----" display indicates that the instrument is trying to make a measurement. After nine unsuccessful tries, Error 31 is displayed.
96 ↔ HP-IB ↔	(HP-IB only) No signal sensed at input.	This error is sent on the HP-IB when the "--" display is shown.
<b>Entry Errors</b>		
20	Entered value out of range.	Re-enter new value.
21	Invalid HP-IB code sequence.	Check for compatibility of functions selected.
22	Invalid Special Function prefix.	Check, then re-enter correct Special Function code. Refer to <i>Special Functions</i> .
23	Invalid Special Function suffix.	Check, then re-enter correct Special Function code. Refer to <i>Special Functions</i> .
24 ↔ HP-IB ↔	Invalid HP-IB code.	Check, then re-enter correct HP-IB code. This error causes a Require Service message to be sent on the HP-IB. Refer to Table 3-4 and accompanying text.
<b>Service Errors</b>		
65—89	Service-related errors.	Refer to paragraph 8-12, <i>Service Errors</i> .

**Related Sections**

Automatic Operation  
RATIO and LOG/LIN

# Filters

## (High-Pass, Bandpass, Low-Pass)

### Description

The optional plug-in high-pass and weighting bandpass, and the LP (low-pass) FILTER keys cause the respective filters to be inserted into the audio signal path. The filters limit the measurement bandwidth. The high-pass and bandpass filters are inserted before the notch filter (control of the notch filter is covered in the *Notch Tune* discussion). The low-pass filters are inserted after the notch filter. When in use, the high-pass, bandpass and low-pass filters always affect the signal at the MONITOR output.

### Procedure

Select the desired signal filters by pressing the appropriate keys. Only one high-pass or bandpass and one low-pass filter can be in use at a time. To turn a filter off, press the key again or select another filter in the same group. HP-IB codes for the different filter keys (shown below) turn on the selected filter (defeating others in the group if on). To turn a high-pass/bandpass or low-pass filter off via HP-IB, use code H0 or L0 respectively, or select the alternate filter in the pair.

### Example

To select the left high-pass or bandpass filter and the 30 kHz low-pass filter:

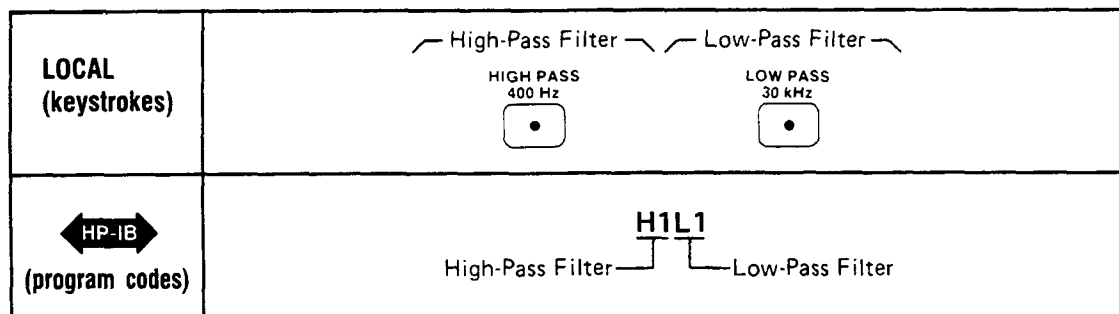

### Program Codes



High-Pass/Bandpass Filter	Program Code HP-IB	Low-Pass Filter	Program Code HP-IB
Both off	H0	Both off (750 kHz low-pass)	L0
Left High-Pass or Bandpass Filter	H1	Low Pass 30 kHz	L1
Right High-Pass or Bandpass Filter	H2	Low Pass 80 kHz	L2

### Indications

When a filter is activated (by either automatic or manual selection), the LED within that filter key will light.

### Comments

Two plug-in positions within the instrument permit the Distortion Analyzer to be configured with various high-pass and band-pass filter combinations. The optional plug-in filter assemblies include a 400 Hz High-Pass (used to filter out 50/60 Hz hum, and squelch signals), and CCITT, CCIR, CCIR/ARM, "A" Weighting, and C-Message Weighting Bandpass Filters. These weighting bandpass filters are all psophometric in nature; each filter characteristic approximates the response of human hearing according to separately established standards.

These optional plug-in filter assemblies may be inserted in either the left-most or right-most key position, according to the filter option number.

## Filters (cont'd)

(High-Pass, Bandpass, Low-Pass)

**Comments  
(cont'd)**

Filter	Left-Most Key Position Filter Option Number	Right-Most Key Position Filter Option Number
400 Hz high pass	010	050
CCITT weighting bandpass filter	011	051
CCIR weighting bandpass filter	012	052
C-Message weighting bandpass filter	013	053
CCIR/ARM weighting bandpass filter	014	054
"A" weighting bandpass filter	015	055

The selected filters are always in the path of the audio signal.

With all filters off, the 3 dB measurement bandwidth is approximately 10 Hz to 750 kHz.

The high-pass or bandpass filters affect the signal being counted; however, the low-pass filters do not. Repeating the HP-IB command to turn on a specific filter has no effect (that is, the filters cannot be toggled on and off using the same HP-IB command).

The individual filter characteristics are given in Table 1-1, *Specifications* and in Table 1-2, *Supplemental Information*.

The optional, weighting bandpass plug-in filter assemblies weights the frequency response of the Distortion Analyzer as shown in their respective curve plots.

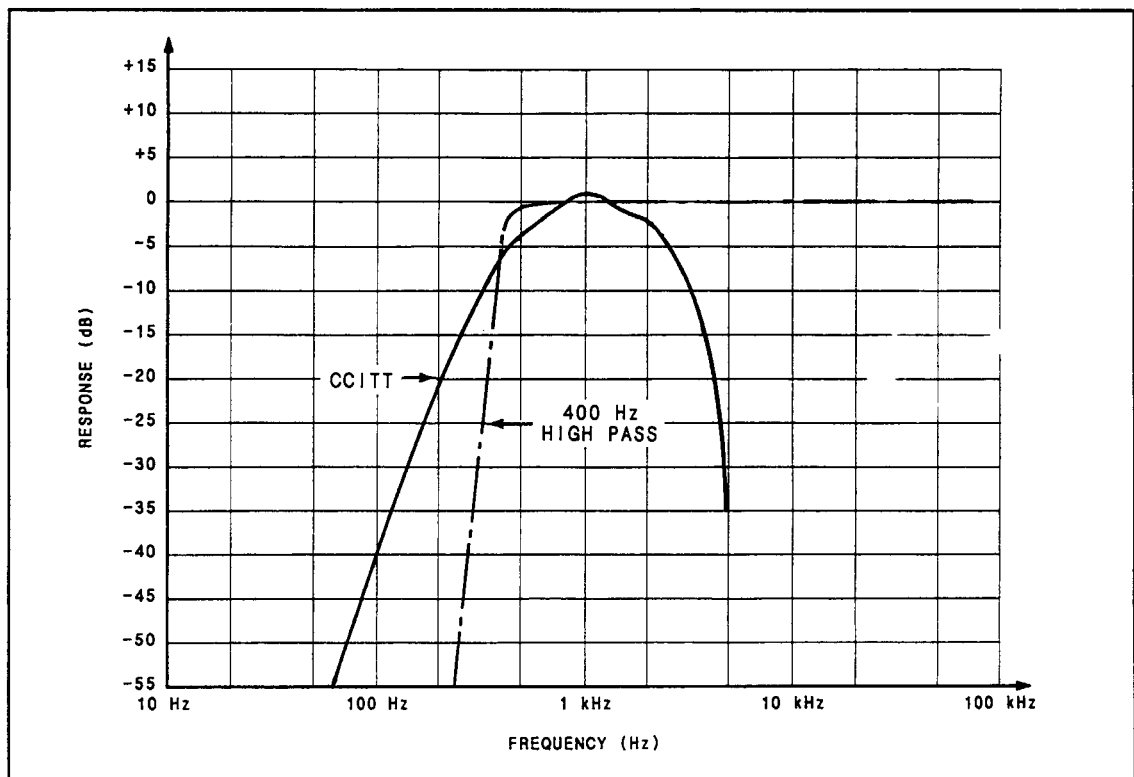

*CCITT and 400 Hz High-Pass Filter Plot*

## Filters (cont'd)

(High-Pass, Bandpass, Low-Pass)

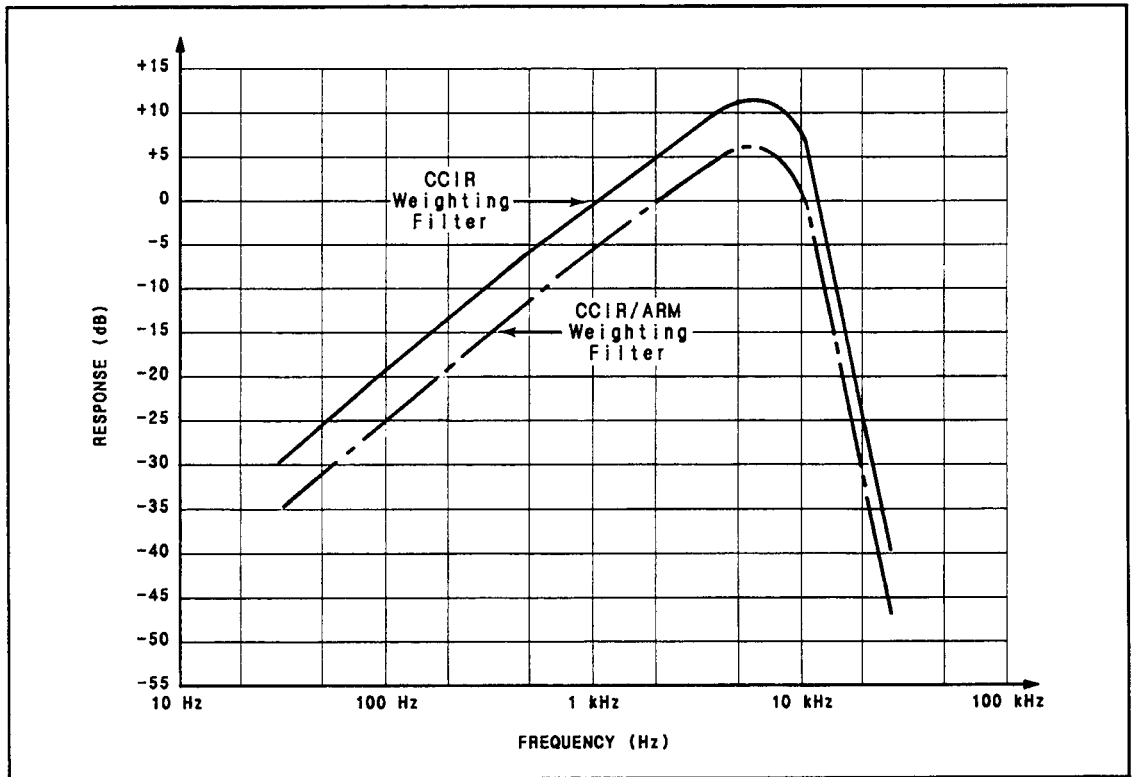

*CCIR and CCIR/ARM Weighting Filter Plot*

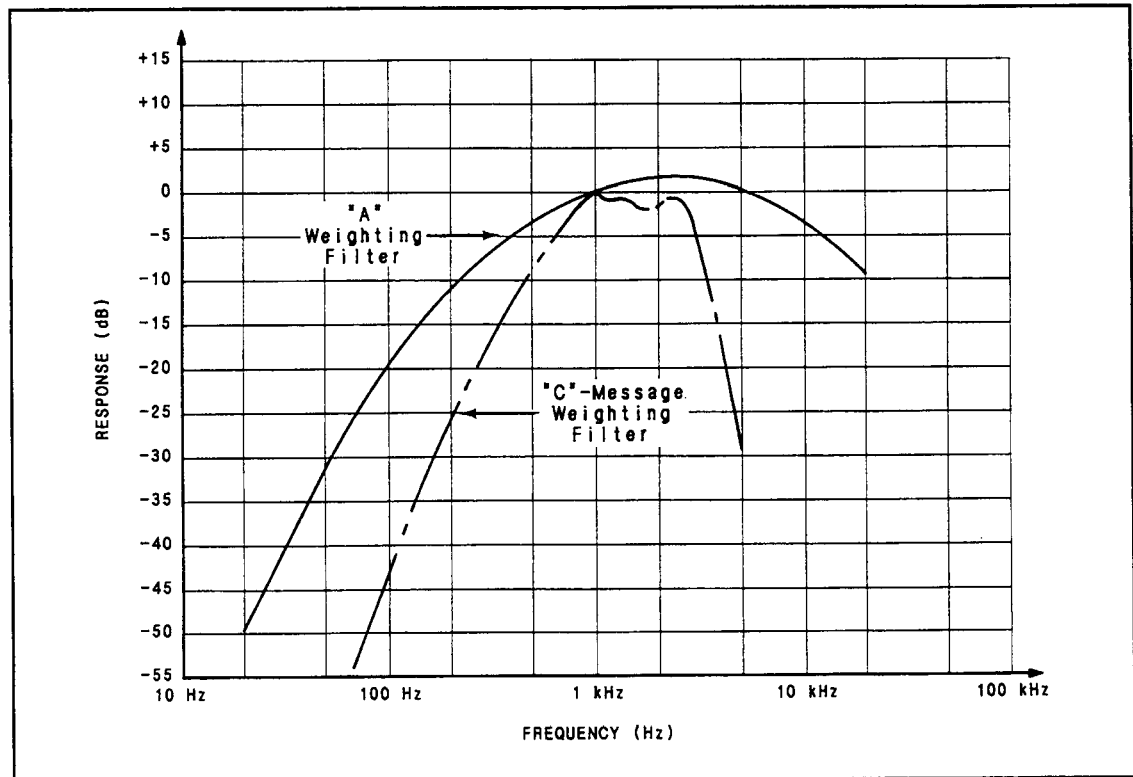

*"A" Weighting and "C"-Message Weighting Filter Plot*



## **Filters (cont'd)**

**(High-Pass, Bandpass, Low-Pass)**

**Related  
Sections**

AC Level  
Distortion  
Distortion Level  
SINAD

## Float

### Description

To minimize measurement errors caused by ground loops, the analyzer input can be floated. Floating the input improves rejection of low frequency and common mode signals (for example, line-related hum and noise). The front-panel FLOAT switch determines whether the input is floating or single-ended. When in the float mode, the analyzer input is fully balanced.

### WARNING

To avoid the possibility of hazardous shock on standard instruments (those without Option 001), do not apply more than 42V peak to the outer conductor of the BNC INPUT connector when the FLOAT switch is in the FLOAT position.

### CAUTION

Do not apply more than 300 Vrms (either differential, common-mode, or a combination) to the INPUT connector(s).

### Procedure

To float the analyzer input, set the FLOAT switch to the FLOAT position. In the float mode the center conductor is the High Input, and the outer conductor is the Low Input that is isolated from chassis ground. In the single-ended mode (the FLOAT switch in the grounded position) the outer conductor is connected directly to chassis ground.

### Comments

The INPUT BNC connector allows the attachment of a shielded cable in the single-ended mode, which minimizes electromagnetic interference (EMI). This is important if the Distortion Analyzer is operated near a transmitter, or in the presence of large RF signals.

When the FLOAT switch is in the grounded position, the outer conductor of the connector is connected to chassis ground.

If EMI shielding is not critical, banana-type connectors can be used. For Option 001, two BNC-to-banana adapters are supplied with the instrument to convert the BNC input and output to dual banana with standard 3/4-inch spacing. The adapters connect the conductor of the banana connector to the center conductor of the BNC connector. These adapters are normally used when the FLOAT switches are set in the FLOAT position.

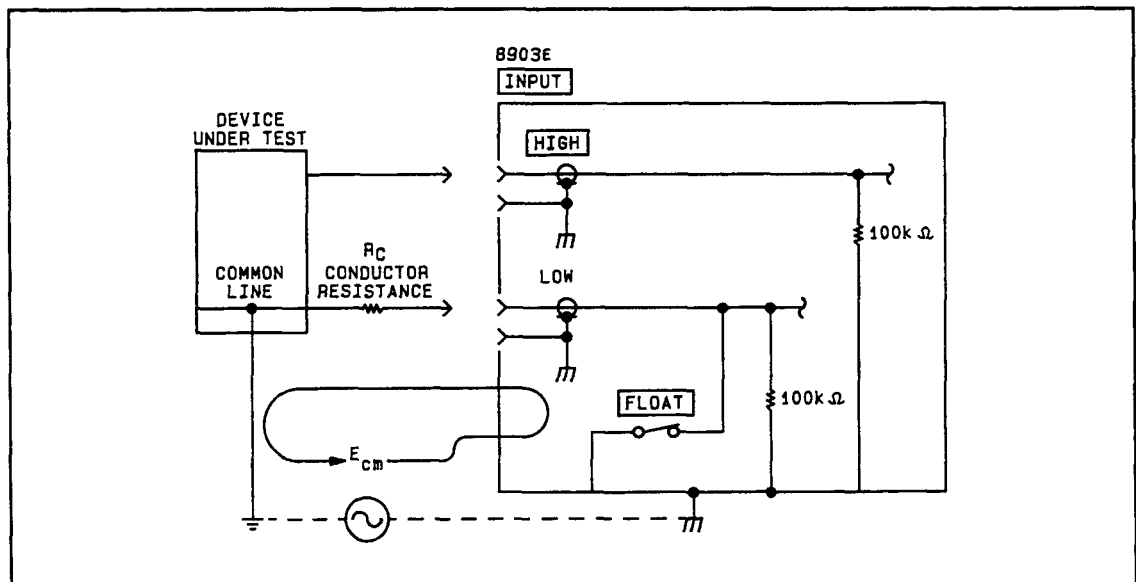

Effect of Multipoint Ground System (FLOAT Switch Closed)

## Float (cont'd)

### Comments (cont'd)

One major source of error which must be considered when measuring low level ac signals or when making low distortion measurements is error introduced by ground loops. The figure above illustrates a typical measurement setup using the Distortion Analyzer. In the figure the system common line is connected to chassis or earth ground at two separate points: the chassis of the Distortion Analyzer and the common point of the device under test. Since two physically separate ground points are seldom at the same ground potential, current will flow in the system common line. Due to conductor resistance (RC) in the system common line, the current causes a voltage drop. This voltage drop (a common mode voltage) sums with the signal under measurement and can cause erroneous readings. Grounding the system common line at a single point minimizes the effect of common mode voltages caused by ground loops. Floating the Distortion Analyzer input circuitry isolates the outer conductor of the Distortion Analyzer from chassis ground. Thus, the Distortion Analyzer input circuits are grounded only through the device under test. Note that the system common line is now grounded at a single point.

# Hold Decimal Point

## (Special Function 4)

**Description** The position of the decimal point in the right display can be held in a specific location by using Special Function 4.

**Procedure** To hold the decimal point in the right display to a specific position, enter the corresponding HP-IB program code.

Decimal Hold Position	Program Code ↔ HP-IB ↔
Automatic Selection	4.0SP
DDDD. V Range*	4.1SP
DDD.D V Range	4.2SP
DD.DD V Range	4.3SP
D.DDD V Range	4.4SP
0.DDDD V Range**	4.5SP
DD.DD mV Range	4.6SP
D.DDD mV Range	4.7SP
0.DDDD mV Range**	4.8SP

\*The decimal point does not appear on the display. It is shown to establish the position it would appear in the numeric value of the readout.

\*\*The zero does not appear on the display. It is shown to clarify the position of the decimal point.

**Example** To hold the decimal point after the first digit of a mV Range (D.DDD mV):

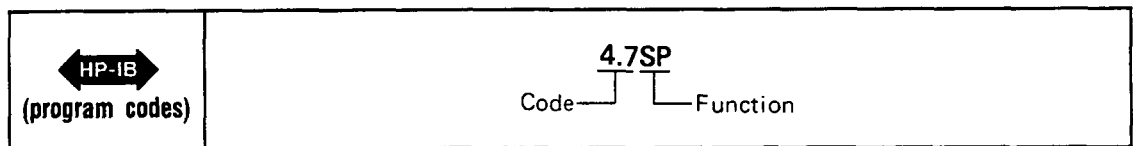

**Program Codes** For HP-IB codes refer to *Procedure* above.



**Indications** As the program code is entered, both displays will blank, and the entered code will flash in the left display. The right display will show the amplitude with the decimal held in the position requested. The left display provides the normal information associated with the selected measurement mode.

**Comments** It is possible to use the Hold Decimal Point Special Function to set the display for a readout that exceeds the resolution of the instrument. For example, in the dc level measurement mode, 4.7SP will set the display to a mV range. In this case, the three digits following the decimal point will always be zeros, and are not significant digits in the amplitude readout.

**Related Sections** Automatic Operation  
Special Functions

# Hold Settings

## (Special Function 9)

**Description** The Hold Settings Special Function is used to freeze the instrument in the presently selected settings for the input level ranges, the post-notch gain, the decimal point position, and the notch tuning.

**Procedure** To hold the presently selected settings for the functions above, enter the HP-IB program code 9.0SP.

**Example** To hold the present settings of the specified functions:

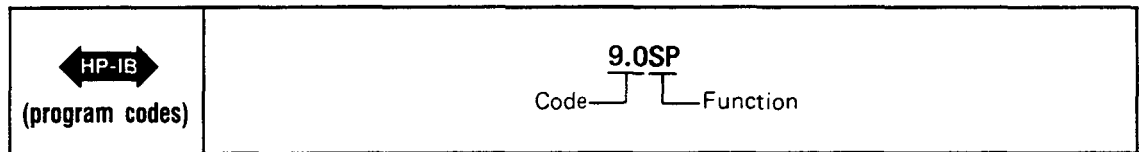

**Program Code** For HP-IB code, refer to *Example* above.



**Indications** As the program code is entered, both displays will blank, and the entered code will appear in the left display. The displays will then show the normal readings for the currently selected measurement mode.

**Comments** Using Special Function 9 is equivalent to entering the following special functions through the HP-IB bus:

- 1.N Input Level Range (Except DC Level)
- 2.N Input Level Range (DC Level Only)
- 3.N Post-Notch Gain
- 4.N Hold Decimal Point (Right Display Only)
- 6.1 Hold Notch Tuning

For Special Functions 1 through 4, N is set equal to the currently selected value that the instrument is using for that function. These values can be read by using the Special Special Display (refer to *Special Functions*).

Note that using the Hold Settings Special Function can cause inaccurate measurements under some circumstances.

Once settings have been held by the Hold Settings Special Function, one or more of them can be reset to their automatic modes by issuing the 0 suffix code of the corresponding Special Function code. As an example, Hold Settings places the instrument in hold notch tuning mode. Use 6.0 SP to re-enter the automatic notch tuning mode.

**Related Sections** Automatic Operation  
Special Functions

# HP-IB Address

## (Special Function 21)

**Description**

The Distortion Analyzer's present HP-IB address can be displayed by using the front-panel S (Shift) LCL keys (for the decimal display). This display is of the form "Addr=" (in the left display) "NN" (in the right display), where "NN" is the HP-IB decimal address. The address set at the factory is 28 (11100 in binary). The HP-IB address can also be displayed using Special Function 21. Information on Special Function 21 is found in *Comments*, below.

**Procedure**

To display the HP-IB address in decimal, key in the S (Shift) LCL keys.

To display the HP-IB address in decimal:

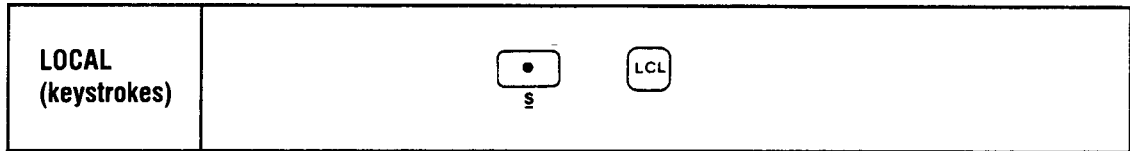

**Indications**

Assuming the same address, the following will be displayed:

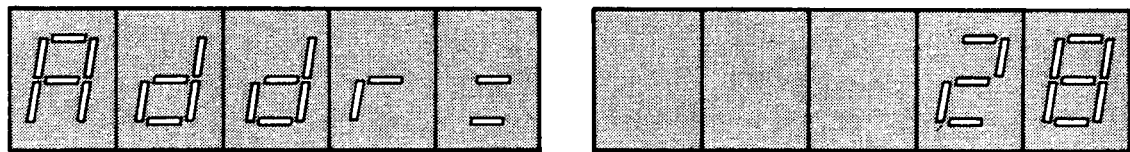

A list of the allowable addresses for the Distortion Analyzer is given below:

Address Switches					Talk Address Character	Listen Address Character	Decimal Equivalent
A5	A4	A3	A2	A1			
0	0	0	0	0	@	SP	0
0	0	0	0	1	A	!	1
0	0	0	1	0	B	"	2
0	0	0	1	1	C	#	3
0	0	1	0	0	D	\$	4
0	0	1	0	1	E	%	5
0	0	1	1	0	F	&	6
0	0	1	1	1	G	'	7
0	1	0	0	0	H	{	8
0	1	0	0	1	I	}	9
0	1	0	1	0	J	*	10
0	1	0	1	1	K	+	11
0	1	1	0	0	L	,	12
0	1	1	0	1	M	-	13
0	1	1	1	0	N	.	14
0	1	1	1	1	O	/	15

Address Switches					Talk Address Character	Listen Address Character	Decimal Equivalent
A5	A4	A3	A2	A1			
1	0	0	0	0	P	0	16
1	0	0	0	1	Q	1	17
1	0	0	1	0	R	2	18
1	0	0	1	1	S	3	19
1	0	1	0	0	T	4	20
1	0	1	0	1	U	5	21
1	0	1	1	0	V	6	22
1	0	1	1	1	W	7	23
1	1	0	0	0	X	8	24
1	1	0	0	1	Y	9	25
1	1	0	1	0	Z	:	26
1	1	0	1	1	[	;	27
1	1	1	0	0	\	<	28
1	1	1	0	1	]	=	29
1	1	1	1	0	^	>	30

**Program Codes** For HP-IB codes refer to the Program Code table under *Comments* following.



## HP-IB Address (cont'd)

### (Special Function 21)

#### Comments

The HP-IB address display is continuously updated. This makes setting the address easy since the result of changing a switch setting is immediately visible on the display. For information on setting the HP-IB address of the Distortion Analyzer, refer to Section 2 of this manual. The factory-set address is, as shown in the examples, decimal 28. The T and L bits are set to 0. The S bit powers up at 0.

To clear the display (from the instrument front panel), press the LCL key, then any function key. The instrument reverts to the new measurement mode.

The HP-IB address can also be displayed via Special Function 21. Since Special Functions can only be executed via HP-IB, the instrument's HP-IB address must be known prior to its use. The primary value of using HP-IB is that the status of the Require Service message can be displayed.

To display the HP-IB address via HP-IB, key in the appropriate HP-IB program code as follows:

Display Format	Program Code ◀ HP-IB ▶
Binary	21.0 SP
Decimal	21.1 SP

As the program code is entered, it will appear on the left display. When the HP-IB code is entered, the top row measurement key lights and annunciators will turn off. If the 21.0 Special Function was entered, the left display will show a binary number of the form AAAAA where AAAAA is the HP-IB address in binary. The right display will show a binary number of the form TLS where the T, L, and S have the meaning indicated in the table on the following page.

	T	L	S
0	NOT TALK ONLY	NOT LISTEN ONLY	NOT REQUESTING SERVICE
1	TALK ONLY	LISTEN ONLY	REQUESTING SERVICE

If T and L are both 1, the instrument is set to talk only (talk overrides listen). If all the A digits are set to 1 and T is 1, the instrument will be in talk status only (that is, output the status byte only). (If all digits AAAAA.TL are 1 but S is 0, the Remote Interface board is not installed.) If the 21.1 Special Function was entered, the left display will show the statement "Addr=" and the right display will show the decimal value of the instrument's HP-IB address (28 if it has not been changed).

#### Related Sections

Remote Operation, Hewlett-Packard Interface Bus  
Special Functions

# Input Level Range (DC Level)

## (Special Function 2)

**Description** In all measurement modes the input level range can be set to a desired range by using Special Function 2.N through HP-IB. The following discussion describes this function formode only. Refer to *Input Level Range (Except DC Level)* for additionthe automatic operation mode, the input level range is determined by both the dc and ac level (if there is one) of the input signal.

**Procedure** To set the input level range to a selected range, or to re-enter the automatic selection mode, the corresponding HP-IB program code.

Input Level Range (Full Scale)	Input Attenuation	Program Code HP-IB
Automatic Selection	—	2.0SP
300V range	40 dB	2.1SP
64V range	24 dB	2.2SP
16V range	12 dB	2.3SP
4V range	0 dB	2.4SP

**Example** To set the input level range to the 16V range:

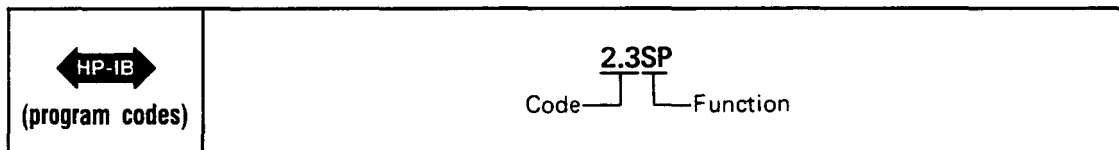

**Program Codes** For HP-IB codes, refer to *Procedure* above.



**Indications** As the program code is entered, it will flash on the left display, which then temporarily blanks out. Note that for all measurement modes except dc level, the left display will return to show the input signal frequency after the HP-IB code is entered.

**Comments** When the Distortion Analyzer powers up, or when Automatic Operation is selected, the input level range is placed in the automatic selection mode.

If the input level range is set such that the input signal level causes the input overload detector to trip, Error 30 will be displayed.

Manually selecting the gain of the input level circuitry can cause measurement error. Measurement accuracy is not specified whenever the gain of the input level circuitry is manually selected because the selected gain setting may be less than optimum. It is important to note that error messages indicating invalid measurements due to incorrect gain settings are not generated unless overload conditions occur. Automatic operation ensures accurate measurements for all combinations of input signals and measurement modes.

- Related Sections**
- Automatic Operation
  - DC Level
  - Input Level Range (Except DC Level)
  - Monitor
  - Special Functions



# Input Level Range (Except DC Level)

## (Special Function 1)

**Description**

In all measurement modes the input level range can be set to a desired range by using Special Function 1.NN through HP-IB. The following discussion describes this function for function for all measurement modes except DC Level mode. Refer to *Input Level Range (DC Level)* for additional information. The input circuitry consists of a programmable attenuator and two programmable amplifiers. In automatic operation mode, the gain of the attenuator-amplifier section of the input is automatically set according to the level of the input signal.

**Procedure**

To set the input level range to a selected range or to re-enter the automatic selection mode, enter the corresponding HP-IB program code.

Input Level Range (Full Scale)	Program Code ↔ HP-IB ↔
Automatic Selection	1.0SP
300V	1.1SP
189V	1.2SP
119V	1.3SP
75.4V	1.4SP
47.6V	1.5SP
30.0V	1.6SP
18.9V	1.7SP
11.9V	1.8SP
7.54V	1.9SP
4.76V	1.10SP
3.00V	1.11SP
1.89V	1.12SP
1.19V	1.13SP
0.754V	1.14SP
0.476V	1.15SP
0.300V	1.16SP
0.189V	1.17SP
0.119V	1.18SP
0.0754V	1.19SP

**Example**

To set the input level range to the 30.0V range:

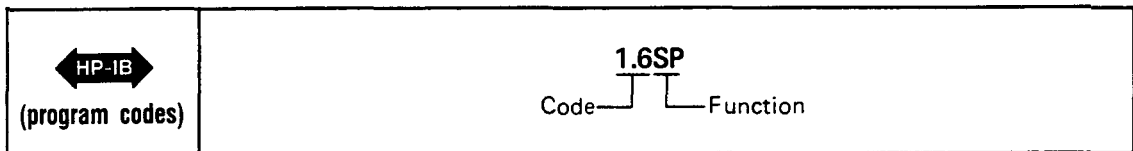

**Program Code** For HB-IB codes, refer to *Procedure* above.



**Indications**

As the program code is entered, it will appear on the left display. The display returns to show the input signal frequency.

## Input Level Range (Except DC Level) (Cont'd)

### (Special Function 1)

**Comments**

When the Distortion Analyzer is first powered up or when Automatic Operation is selected, the input level range is placed in the automatic selection mode. If the input level range is set such that the input signal level creates an overrange condition, an error message will be displayed. The error message generated depends on instrument settings and the input signal level. For example, if the input level range is set such that the input signal level causes the input overload detector to trip, Error 30 will be displayed. For a complete listing of the error messages, refer to *Error Message Summary*.

Manually selecting the gain of the input level circuitry can cause measurement error. Measurement accuracy is not specified whenever the gain of the input level circuitry is manually selected because the selected gain setting may be less than optimum. It is important to note that error messages indicating invalid measurements due to incorrect gain settings are not generated unless overload conditions occur. Automatic operation ensures accurate measurements for all combination of input signals and measurement modes.

**Related Sections**

- AC Level
- Automatic Operation
- Input Level Range (DC Level)
- Monitor
- Special Functions

# Monitor

**Description** The MONITOR output provides a means of monitoring the ac signal into the output rms detector. The auto-ranging MONITOR output level is normally a 0.3 to 3 Vrms signal which is proportional to the input signal. In ac level and dc level the MONITOR output provides a scaled representation of the ac component of the input signal. In SINAD, distortion, and distortion level the MONITOR output provides a scaled representation of the input signal with the fundamental removed. The output is dc coupled with a 600Ω output impedance, and a BNC female connector. The MONITOR output can be used to drive other test instruments, such as an oscilloscope, wave analyzer, or spectrum analyzer for further analysis.

**Block Diagram** A simplified block diagram of the Distortion Analyzer measurement circuits illustrating the relationships between the MONITOR output and the other circuit blocks is shown below. The MONITOR output block diagram illustrates the signal path from the INPUT to the MONITOR output. The diagram is that of a programmable gain amplifier with a tunable notch filter. In ac level and dc level, the notch filter is bypassed. In SINAD, distortion, and distortion level the notch filter is switched into the signal path, removing the fundamental frequency.

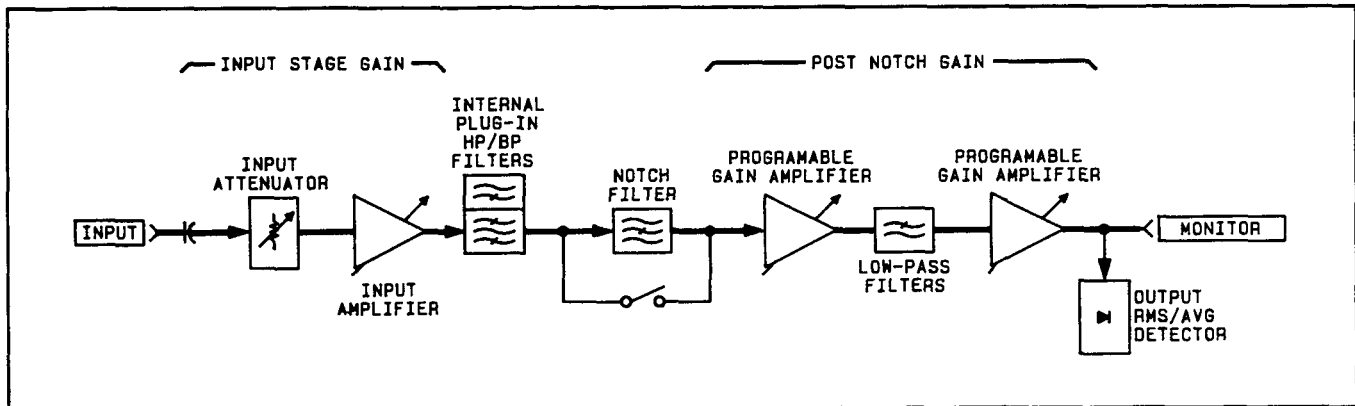

*Monitor Output Block Diagram*

**Comments** The MONITOR output gain and sensitivity (that is, the net signal gain from the INPUT to the MONITOR output) are dependent on the input stage gain and the post-notch gain. Both the input stage gain and the post-notch gain can be determined by viewing the Special Special Display (refer to *Special Functions*).

The input stage gain, and post-notch gain for various instrument settings are listed in the tables below.

## Monitor (Cont'd)

Comments  
(Cont'd)

INPUT STAGE GAIN (Except dc)			
Special Display 1.NN	Input Level Range	Gain	
		Log (dB)	Linear
1.1	300V	-40	0.0100
1.2	189V	-36	0.0158
1.3	119V	-32	0.0251
1.4	75.4V	-28	0.0398
1.5	47.6V	-24	0.0631
1.6	30.0V	-20	0.1000
1.7	18.9V	-16	0.1585
1.8	11.9V	-12	0.2512
1.9	7.54V	-8	0.3981
1.10	4.76V	-4	0.6310
1.11	3.00V	0	1.00
1.12	1.89V	+4	1.58
1.13	1.19V	+8	2.51
1.14	0.754V	+12	3.98
1.15	0.476V	+16	6.31
1.16	0.300V	+20	10.00
1.17	0.189V	+24	15.85
1.18	0.119V	+28	25.12
1.19	0.0754V	+32	39.81

POST-NOTCH GAIN		
Special Display 3.N	Gain	
	Log (dB)	Linear
3.1	0	1
3.2	+20	10
3.3	+40	100
3.4	+60	1000

The measurement system net gain equals the combined gain of the two stages. To calculate the net gain use the following formulas:

$$\text{Net Gain (LOG)} = \text{Input Stage Gain (LOG)} + \text{Post-Notch Gain (LOG)}$$

or

$$\text{Net Gain (LIN)} = \text{Input Stage Gain (LIN)} \times \text{Post-Notch Gain (LIN)}$$

In ac level the MONITOR output is a scaled replica of the input signal. The MONITOR output level is calculated as:

$$V_{\text{out}} = V_{\text{in}} \times \text{Net Gain}$$

where  $V_{\text{in}}$  is the input signal level and the linear net gain is used.

## Monitor (Cont'd)

### Comments (Cont'd)

In SINAD, distortion, and distortion level, the fundamental frequency is removed (suppressed) by more than 80 dB. The output after the notch filter includes all harmonics of the fundamental plus any noise, hum, and other spurious signals that may be present. These signal impurities are amplified and are available at the MONITOR output for further analysis.

The following equations express the MONITOR output level as a function of the parameter being measured (the displayed reading). (Use linear Net Gain.) For distortion:

$$V_{\text{out}} = \frac{\text{Displayed Reading (in \%)} \times V_{\text{in}} \times \text{Net Gain}}{100}$$

or

$$V_{\text{out}} = 10^{\text{Displayed Reading (in dB)}/20} \times V_{\text{in}} \times \text{Net Gain}$$

For distortion level:

$$V_{\text{out}} = \text{Displayed Reading (in volts)} \times \text{Net Gain}$$

or

$$V_{\text{out}} = 10^{\text{Displayed Reading (in dBm)}/20} \times \text{Net Gain}$$

For SINAD:

$$V_{\text{out}} = \frac{100}{\text{Displayed Reading (in \%)}} \times V_{\text{in}} \times \text{Net Gain}$$

or

$$V_{\text{out}} = 10^{-\text{Displayed Reading (in dB)}/20} \times V_{\text{in}} \times \text{Net Gain}$$

In the above equations  $V_{\text{out}}$  is the MONITOR output level as measured with a true rms voltmeter and  $V_{\text{in}}$  is the input signal level.

The MONITOR output does not respond to dc signals presented at the INPUT. In the dc level measurement mode only the ac components of the input signal are presented at the MONITOR output.

### Related Sections

AC Level  
DC Level  
Distortion  
Distortion Level  
Input Level Range (DC Level)  
Input Level Range (Except DC Level)

# Notch Tune

## (Special Function 6)

**Description** In SINAD, distortion, and distortion level modes, the Distortion Analyzer automatically tunes the notch filter to the input frequency. By means of keyboard entry using the NOTCH key, the notch filter can be held to the current notch filter frequency setting.

**Procedure** To freeze the notch filter, press the NOTCH TUNE key. To return to the automatic tuning mode, press the NOTCH TUNE key again, or enter the HP-IB program code N0 or 6.0SP.

Notch Tune	Program Code ↔ HP-IB ↔
Automatic Notch Tuning	6.0SP or N0
Hold Notch Tuning	6.1SP or N1

**Example** To freeze the notch filter, press NOTCH TUNE:

<b>LOCAL (keystrokes)</b>	Notch Tune 	
<b>↔ HP-IB ↔ (program codes)</b>	N1   Function	or Code <u>6.1SP</u>   Function

**Program Codes** The above procedure gives the HP-IB codes N0 and N1 for the Notch Tuning function. Notch Tuning may also be controlled over HP-IB with Special Functions 6.0 and 6.1.

**Indications** When the NOTCH TUNE key is pressed, the LED within the NOTCH TUNE key will light, indicating the notch filter is on. Pressing the NOTCH TUNE key again will turn off the key light, indicating the notch filter is off.

When either HP-IB program code 6.0SP or 6.1SP is entered, the program code will flash on the left display. The display blanks, then shows the input signal frequency. For HP-IB program code 6.1SP the light within the NOTCH TUNE key will turn on. The light will turn off for HP-IB program code 6.0SP. When the HP-IB program codes N0 or N1 are used, there is no numeric code shown in the left display.

**Comments** When the Distortion Analyzer first powers up or when Automatic Operation is selected (NOTCH TUNE key light is off), the Distortion Analyzer is placed in the automatic notch tuning mode.

In the automatic tuning mode the Distortion Analyzer counts the frequency of the input signal, then coarsely tunes the notch filter to that frequency. The notch filter is then fine tuned via circuitry internal to the notch filter. In the hold tune mode, the notch filter is no longer coarsely tuned, however the fine tune circuitry still remains operational. Thus the notch filter still automatically tunes, but now over a limited range. In the hold tuning mode the tuning or nulling range of the notch filter is approximately 5% of the frequency of the original notch filter setting.

**Related Sections**  
 Automatic Operation  
 Distortion  
 Distortion Level  
 SINAD  
 Special Functions

# Post-Notch Detector Filtering (Except SINAD)

## (Special Function 5)

**Description** The Distortion Analyzer normally makes audio measurements using a fast-responding detector. By means of HP-IB program code entry, additional low-pass filtering can be added after the post-notch detector. The additional low-pass filtering (slow detector) is useful in stabilizing measurements on unstable or noisy signals, or whenever display jitter is considered excessive.

**Procedure** To change the Distortion Analyzer post-notch filtering response from fast to slow or vice versa, enter the corresponding HP-IB program code.

Post-Notch Detector Response	Program Code ◀ HP-IB ▶
Fast RMS Detector	5.0SP
Slow RMS Detector	5.1SP
Fast AVG Detector	5.2SP
Slow AVG Detector	5.3SP

**Example** To enter a slow rms detector response mode:

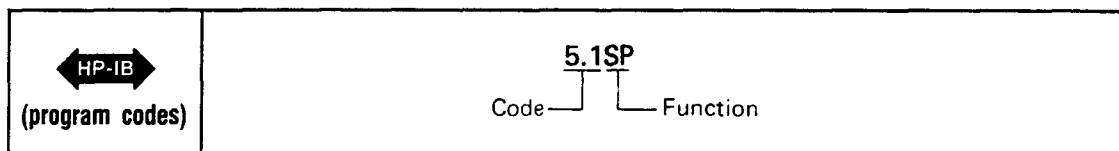

**Program Codes** For HP-IB codes, refer to the *Procedure* above.



**Indications** As the HP-IB program code is entered, it will flash on the left display, with the display returning to show the input signal frequency. When HP-IB program code 5.2SP or 5.3SP is entered, the LED within the AVG/RMS key will light if not already on. If the light is already on, it will remain on. When HP-IB program code 5.0SP or 5.1SP is entered, the LED within the AVG/RMS key will turn off (if not already off).

**Comments** When the Distortion Analyzer is first turned on or when Automatic Operation is selected, the fast rms detector is selected.

In SINAD, additional low-pass filtering is always used. Fast detection (either rms or avg) cannot be selected by means of HP-IB entry when in SINAD. Slow detection can be used when in SINAD.

**Related Sections** Automatic Operation  
Special Functions

# Post-Notch Gain

## (Special Function 3)

**Description** The overall stage gain of the post-notch circuit can be manually set by HP-IB program code entry. The gain is selectable from 0 dB to 60 dB in 20 dB steps. In automatic operation mode, the instrument will automatically select the optimum post-notch gain.

**Procedure** To manually set the gain of the post-notch circuit, or to re-enter the automatic selection mode, enter the corresponding HP-IB program code.

Post-Notch Gain	Program Code ↔ HP-IB ↔
Automatic Selection	3.0SP
0 dB gain	3.1SP
20 dB gain	3.2SP
40 dB gain	3.3SP
60 dB gain	3.4SP

**Example** To set the post-notch gain to 40 dB:

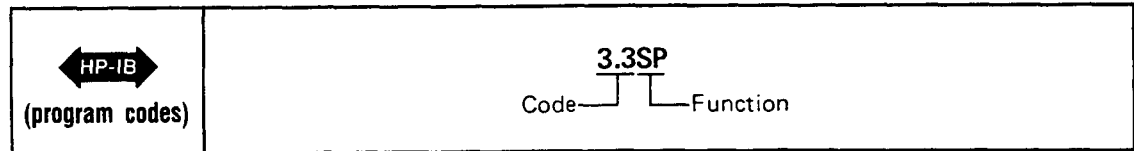

**Program Codes** For HP-IB codes, refer to *Procedure* above.



**Indications** As the program code is entered, it will flash on the left display, the display then returns to show the input signal frequency.

**Comments** When the Distortion Analyzer is first powered up, or when Automatic Operation is selected, the Distortion Analyzer is placed in the automatic selection mode.

If the post-notch gain is set such that the input signal level causes the post-notch circuitry to be overdriven, four dashes will be displayed on the right display. If this overload condition is not corrected within nine measurement cycles, Error 31 will be displayed.

Manually selecting the gain of the post-notch circuit can cause measurement error. Measurement accuracy is not specified whenever the gain of the post-notch circuitry is manually selected because the selected gain setting may be less than optimum. It is important to note that error messages indicating invalid measurements due to incorrect gain settings are not generated unless overload conditions occur. Automatic operation ensures accurate measurements for all combination of input signals and measurement modes.

**Related Sections**  
 Automatic Operation  
 Monitor  
 Special Functions



# Rapid Frequency Count

## Description

Rapid Frequency Count mode allows a remote controller to partially bypass the Distortion Analyzer's own internal controller. The advantage is that frequency count measurements can then be obtained from the Distortion Analyzer much more quickly. The data obtained, however, is in a packed binary form, and thus requires additional processing to produce the final results in hertz (Hz). Once the Rapid Frequency Count mode is entered, data will be placed on the bus in four-byte sequences until the mode is terminated. Rapid Frequency Count mode is terminated whenever the Distortion Analyzer receives a bus command, or whenever it is sent new programming data.

## Procedure

To use the Rapid Frequency Count mode, the remote controller must be able to read the four-byte compacted frequency data using a binary specifier. First, place the Distortion Analyzer into the ac level measurement mode, set it to measure the input signal (that is, the signal before the notch filter), and to trigger with settling. The HP-IB codes for this configuration are M146.1SPT3. Next, issue the HP-IB code for Rapid Frequency Count (RF) and then read the frequency data from the Distortion Analyzer. The Distortion Analyzer does not send carriage return, line feed, or any other characters as delimiters.

The frequency data will be in the form shown below:

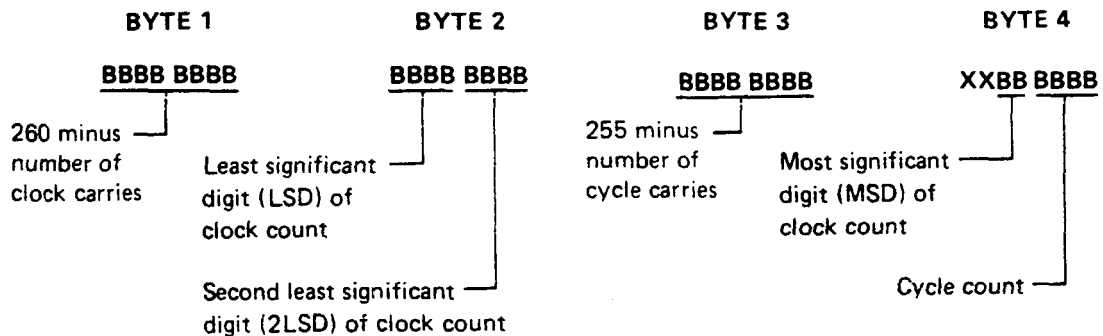

To obtain the frequency, compute:

$$\text{Total clock counts} = \text{LSD} + 16(2\text{LSD}) + 256(\text{MSD}) + 1024(260 - \text{BYTE 1})$$

$$\text{Total cycle counts} = \text{Cycle count} + 16(255 - \text{BYTE 3})$$

$$\text{Frequency} = \frac{\text{Total cycle counts}}{\text{Total clock counts}} \times (2 \cdot 10^6)$$

Where:

LSD = Least significant digit of clock count

2LSD = Second least significant digit of clock count

MSD = Most significant digit of clock count

Using a BASIC controller such as the Hewlett-Packard Model 85B Desktop Controller, the computation is set up in seven steps as shown below:

```

10 OUTPUT 728 USING "K" ; "46.1SPT3,RF"
20 ENTER 728 USING "#,B" ; A,B,C,D
30 T=IP(B/16)+16*BINAND(B,15)+16*BINAND(D,48)+1024*(260-A)
40 E=BINAND(D,15)+16*(255-C)
50 F=IP(E/T*200000000)/100
60 DISP F
70 END
    
```

## Rapid Frequency Count (cont'd)

### Procedure (cont'd)

Explanation:

Line 10: Places the Distortion Analyzer in the Rapid Count Mode ("46.1SPT3" sets up the analyzer for transient free operation).

Line 20: Enter the four rapid count bytes using the Binary format "#,B".

Line 30: Calculate T=total clock counts by bit manipulation and proper weighting.

Line 40: Calculate E=total cycle counts by bit manipulation and proper weighting.

Line 50: Calculate the frequency  $F=(\text{total cycle count}/\text{total clock count}) \times 2 \cdot 10^6$ . Note that the value is multiplied by 100 to round the integer part and then divide by 100 to round the answer to 2 digits to the right of the decimal.

Line 60: Displays the frequency count result.

Line 70: Terminates the program.

Using a HPL controller such as the Hewlett-Packard Model 9825A Desktop Controller, the computation is set up in seven steps as shown below:

```

0: wrt 728, "RF"
1: fmt, z, 4b
2: red 728, r1, r2, r3, r4
3: shf (r2, 4) + 16 (band (r2, 15) + band (r4, 28)) + 1024 (260 -r1) → r5
4: band (r4, 15) + 16 (255 -r3) → r6
5: 2e6r6/r5 → B
6: dsp B
7: end

```

Explanation:

Line 0: Place the Distortion Analyzer in the Rapid Frequency Count mode.

Steps 1,2: Establish a format suitable for reading four binary bytes from the Distortion Analyzer. Take the readings and store the value in four "r" variables. The value stored is the decimal equivalent of the binary word.

Line 3: Shift various bytes around and weight their value by the proper amount (in accordance with the routine given) to obtain the number of Distortion Analyzer clock counts. Assign that value to variable "r5".

Line 4: Position bits correctly and weight appropriately to determine the number of cycle counts. Assign that value to variable "r6".

Line 5: Since the Distortion Analyzer uses a reciprocal counter, the frequency of the input signal equals the number of input cycles (r6) divided by total time elapsed during these input cycles. The denominator is determined by counting the number of 2 MHz clock counts that occur during these input cycles and multiplying by the frequency of the clock (2 MHz). Total time equals number of clock counts divided by  $2 \cdot 10^6$ .

$$\text{Total time (seconds)} = \frac{r5}{2 \cdot 10^6}$$

Thus:

$$\text{Input frequency (Hz)} = \frac{r6}{r5/2 \cdot 10^6} = \left( \frac{r6}{r5} \right) \times 2 \cdot 10^6$$

Line 6: Displays the frequency count result.

Line 7: Terminates the program.

## Rapid Frequency Count (cont'd)

**Program Code** Program Code RF is the HP-IB code that initiates the Rapid Frequency Count mode.



**Indications** When in Rapid Frequency Count mode, the Distortion Analyzer's left display will show " \_ \_ \_ \_ \_".

**Comments** The major advantage of Rapid Frequency Count mode is that data can be taken in rapid sequence and stored in an array in the computing controller. Then, at a later time when operations do not require immediate controller attention, the packed binary data can be converted into decimal frequency data. This way the time required for the Distortion Analyzer to process the data into decimal frequency is eliminated. This greatly increases its measurement speed for measuring tone burst sequences.

# RATIO and LOG/LIN

## (Special Function 11)

**Description**

The RATIO key can be used to compare any measurement (except frequency and power) to a reference value. The reference value can be the result of a previous measurement. The LOG/LIN (logarithmic/linear) key can be used to express the results in logarithmic or linear units. The following table shows which units are applicable to the individual measurement modes:

Measurement Mode	RATIO On		RATIO Off*	
	LIN	LOG	LIN	LOG
AC LEVEL	%	dB	V or mV*	dBm into 600Ω
DC LEVEL	%	dB	V or mV	dBm into 600Ω
SINAD	%	dB	%	dB*
DISTN	%	dB	%*	dB
DISTN LEVEL	%	dB	V or mV*	dBm into 600Ω

\*After initial power on, switching measurement mode results in the configuration indicated by the asterisks. In subsequent operations, the last setting of the LOG/LIN key is remembered for each measurement mode and applied to the new measurement.

When the RATIO LED is on, the measurement result is compared to a reference value. The reference value can be the result of a previous measurement. The LOG/LIN key allows any measurement result to be viewed in linear or logarithmic format.

The Distortion Analyzer stores only one ratio reference at a time. When in ratio, if a new measurement is selected, ratio is disabled.

When returning to the previous measurement, it is possible to re-enter the ratio mode with the same factor as before using HP-IB program code 11.0. Additionally, the ratio reference can be displayed using HP-IB program code 11.1.

**Procedure**

To use the RATIO key, set the display to the desired reference value. This can be done by adjusting the signal parameter being measured to a reference setting, or by entering the numeric reference via the HP-IB, followed by HP-IB code R1. The entry must be made in fundamental units (for example, for a ratio reference of 60 mV enter .06 regardless of the displayed value). The display will show the measurement result relative to the reference value. The units used with the right display depend upon the setting of the LOG/LIN key (see table above). Pressing the LOG/LIN key alternates the display between the LOG and the LIN functions. When the measurement mode is changed, the last setting of the LOG/LIN key for that mode is remembered and applied to the new measurement.

To re-enter ratio with the previous ratio reference or to read the reference, enter in the corresponding HP-IB program code. The special function codes are listed as follows:

Ratio Operation	Program Code ↔ HP-IB ↔
Re-enter ratio with the previous reference.	11.0SP
Read ratio reference.	11.1SP

**Examples**

If the display shows 100 mV, to enter this value as the RATIO reference for future measurements:

## RATIO and LOG/LIN (cont'd)

### (Special Function 11)

**Examples (cont'd)**

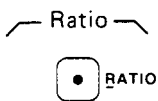
<p><b>LOCAL</b> (keystrokes)</p>	
<p style="text-align: center;"><b>HP-IB</b></p> <p>(program codes)</p>	<p><b>R1</b></p> <p>Ratio</p>

If the display shows 0.100V, to compare this to a value of 2V:

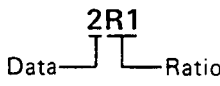
<p style="text-align: center;"><b>HP-IB</b></p> <p>(program codes)</p>	
--	--

**Program Codes**

The HP-IB codes for re-entering ratio or for reading the reference are given above. The HP-IB codes for the RATIO and LOG/LIN keys are given below:



Function	Program Code <b>HP-IB</b>
LOG	LG
LIN	LN
RATIO Off	R0
RATIO On	R1

**Indications**

When the instrument is displaying a ratio measurement, the RATIO key lights. The status of the LOG/LIN key can be determined by observing the the current measurement mode, the measurement unit lights, and the table above.

**Comments**

The ratio mode can also be used to view an extra digit of resolution when the right display is only showing three digits. Depending upon the current value displayed, entering either 100R1 or 1R1 will cause an unscaled right display readout (that is, the numbers are correct but the decimal point may not be in the correct position). However, an extra digit of resolution is displayed (for example, if 1.58 was originally displayed, the new display might indicate 1.576). Note that the units annunciator will change to % and should be interpreted properly.

Ratio cannot be used with a frequency measurement. Also, if a negative reference is entered, the ratio indication will be displayed in absolute (unsigned) value.

The LOG function cannot be used with a reference that is zero or negative. If the reference is zero, Error 20 (entered value out of range) is displayed. If the reference is negative, Error 11 (calculated value out of range) is displayed.

**Related Sections**

- AC Level
- DC Level
- Distortion
- Distortion Level
- Error Message Summary
- SINAD
- Special Functions

# Read Display to HP-IB

## (Special Function 20)

**Description** The Distortion Analyzer can be set to read the information shown in either the left or right display to the HP-IB bus. Using Special Function 20 through HP-IB allows the operator to manually determine which display's information will be placed on the HP-IB bus. This capability is typically used in the Talk Only Mode when logging data to a monitoring device. (Note that when set to Listen Only, the Distortion Analyzer cannot place data on the bus. If it is set to talk and listen both, front-panel control is relinquished and HP-IB codes RR and RL determine the data output.)

**Procedure** To set the Distortion Analyzer to output data to the HP-IB from either the left or right display, enter the corresponding HP-IB program code.

Display Read	Program Code ↔ HP-IB ↔
Right	20.0SP (or RR)
Left	20.1SP (or RL)

**Example** To read the left display to the HP-IB:

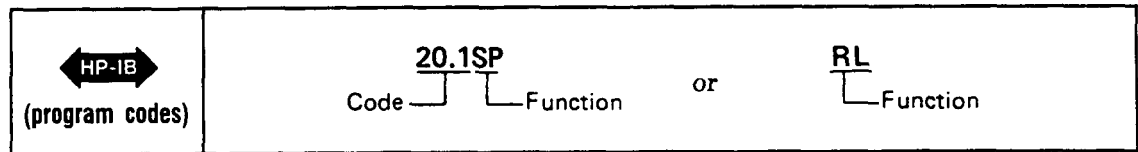

**Program Code** For HP-IB codes, refer to the table in the *Procedure* above.



**Indications** As the program code is entered, both displays will blank, the entered code will flash in the left display, and four dashes will momentarily appear in the right display. Both displays then return to the display that is appropriate for the current measurement mode.

**HP-IB Output** The instrument outputs data from the display in the following format:

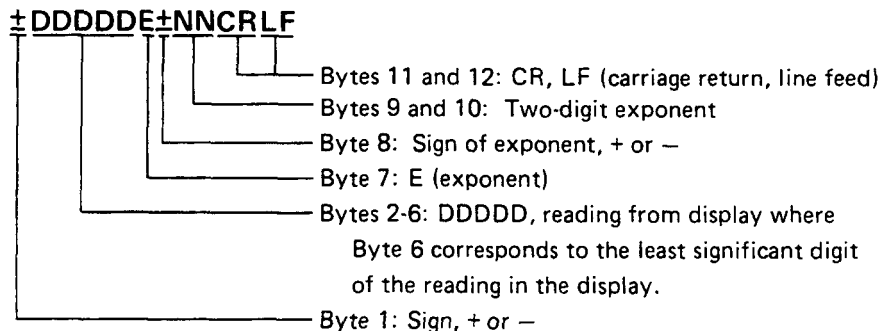

Data is always output in fundamental units (that is, Hz, %, dB, or V).

Error messages and the voltage value in dc level mode are always read out regardless of the status of the Read Display to HP-IB commands.

**Related Sections**

Special Functions

# Service Request Condition

## (Special Function 22)

**Description**

The Distortion Analyzer will issue a Require Service message under various circumstances. For example, a Require Service message will always be issued if an HP-IB code error occurs. Using HP-IB program codes, the operator may enable one or more conditions to cause the Require Service message to be issued. Whenever the enabled condition occurs, it sets both the bit corresponding to the condition, and bit 7 (RQS bit) in the Status Byte. The bits set in the status byte and the Require Service message are not cleared unless the status byte is read (by serial polling), a Clear message is received and executed by the Distortion Analyzer, or a Controller Reset or Controller Clear Service Special Function is performed. The enabled Service Request conditions are always disabled again whenever a Clear message is received and executed by the Distortion Analyzer, or whenever a Controller Reset, or Controller Clear Service Special Function is performed. Automatic operation does not clear a Require Service message.

**Procedure**

To enable one or more conditions to cause the Distortion Analyzer to issue a Require Service message, sum the weights of the conditions to be enabled (from the table below). This sum becomes the code suffix of Special Function 22. Enter the special function code (prefix, decimal, and suffix) via the HP-IB program code. An HP-IB code error (weight 2) will always cause a Require Service message. This condition cannot be disabled, and if the weight is not summed in, it will be assumed by the instrument.

Condition	Weight
Data ready	1
HP-IB code error	2
Instrument error	4

**Example**

To set the Distortion Analyzer to send a Require Service message when an instrument error occurs (or when an HP-IB code error occurs) first compute the special function suffix by summing the weights corresponding to those conditions:

$$(2) + 4 = 6$$

Then enter the code:

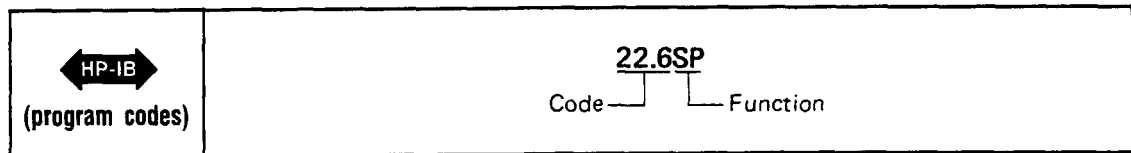

**Program Code**

Compute the special function code as described under *Procedure* above.



## Service Request Condition (cont'd)

### (Special Function 22)

**Indications**

As the HP-IB program code is entered, it will flash on the front-panel display, then the display returns to show the measurement previously selected. When any enabled condition occurs, both the RQS bit and the bit corresponding to the enabled condition are set in the status byte, and the SRQ control line on the HP-IB will be set true. The Distortion Analyzer's status byte is shown below for reference.

*Distortion Analyzer's Status Byte*

Bit	8	7	6	5	4	3	2	1
Weight	128	64	32	16	8	4	2	1
Condition	0 (always)	RQS	0 (always)	0 (always)	0 (always)	Instru- ment Error	HP-IB Code Error	Data Ready

**Comments**

For more information on HP-IB operation, serial polling, and the Status Byte message, refer to the HP-IB discussion titled *HP-IB Operation* appearing earlier in Section 3 of this manual.

The HP-IB Address Special Function provides a convenient means to determine at any time whether a Require Service message is being issued by the Distortion Analyzer.

**Related Sections**

HP-IB Address  
 HP-IB Operation (appears earlier in Section 3)



# SINAD

**Description** The Distortion Analyzer measures SINAD (Signal to Noise And Distortion) by first determining the following value:

$$S = \frac{\text{signal, noise, and distortion}}{\text{noise and distortion}}$$

S is then converted into the appropriate measurement units as follows:

$$\% \text{ units} = S \times 100\%$$

$$\text{dB units} = 20\log S$$

A SINAD measurement can be made on signals from 20 Hz to 100 kHz and from 50 mV to 300V in the single-ended mode (FLOAT switch in grounded position). SINAD measurements are generally made to determine the sensitivity of a receiver. In SINAD mode, the Notch Filter tunes to the Counter Frequency. However, with noisy input signals (SINAD ratios less than 15 dB), the signal is too noisy and unsettled for a good reading. Consequently, the notch filter jumps around trying to lock on to the input signal. The resulting SINAD reading will probably be erroneous. The following procedure will allow you to make stable SINAD measurements at any SINAD ratio.

**Procedure** First, input a clean external source signal (SINAD ratio greater than 20 dB), with Notch Tune on automatic tuning (NOTCH TUNE off). Press S (Shift) SINAD. This allows the Notch Filter to tune to the input frequency. Freeze the notch filter by pressing the NOTCH TUNE key. This locks the Notch Filter onto the input frequency. Enter your desired signal to be measured (SINAD less than 15 dB), but at the same external source frequency. The SINAD ratio measurement is read on the right display.

**Example** To select SINAD:

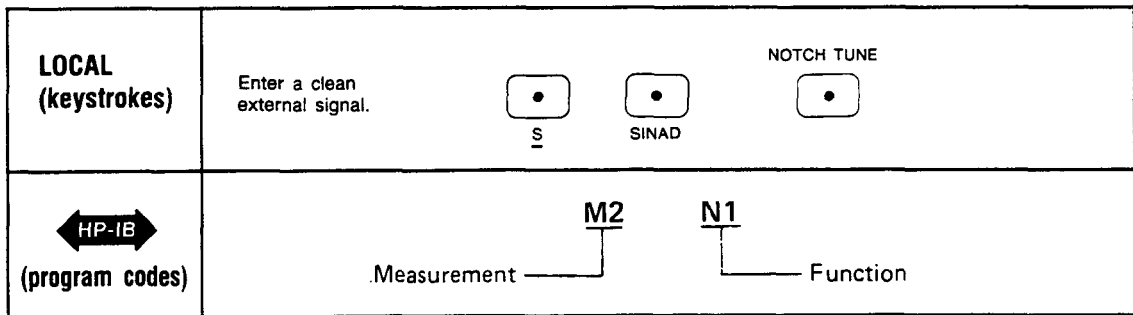

**Program Code** M2 is the HP-IB code for the SINAD measurement.



**Indications** When the HP-IB program code is entered, both displays blank and four dashes are momentarily displayed in the right display. The displays then return to the normally displayed information for the currently selected measurement mode. The LEDs in the DISTN/SINAD and S keys light and the appropriate SINAD information for the input signal is displayed.

## SINAD (cont'd)

### Measurement Technique

In the SINAD measurement mode, the controller automatically sets the input attenuation and the gain of various amplifiers. This is accomplished by measuring the signal with the ranging rms detector. This control ensures that the signal amplitude is within the proper range of the input and output detectors. The input detector converts the combined signal + noise + distortion ac signal to dc. The notch filter then removes the fundamental signal and the output detector converts the noise + distortion ac signal to dc. The dc voltmeter measures both signals. The controller then corrects for the programmed gain and attenuation, computes the ratio, and displays the results in the appropriate units. The frequency of the input signal is also measured and displayed.

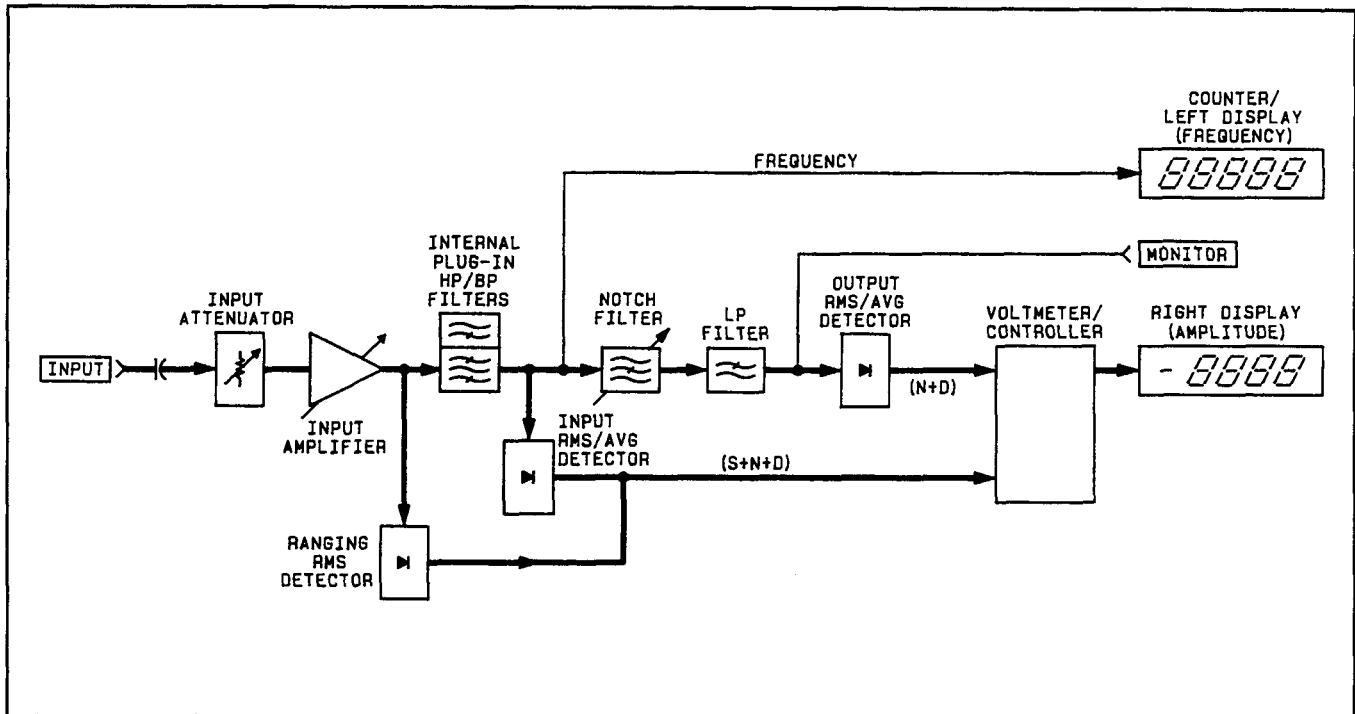

*SINAD Measurement Block Diagram*

### Comments

During a SINAD measurement, the output detector uses increased filtering to obtain more consistent readings in the presence of noise.

SINAD can be measured with either the true rms or average responding detector. Most applications specify true rms detection.

The Distortion Analyzer powers up with Special Function 16.1 active for 0.0 dB resolution at all SINAD ratios. Special Function 16.0 rounds the digital display to 0.5 dB to reduce digit flicker, for SINAD ratios less than 25 dB.

### Related Sections

Detector Selection  
Special Functions

## Special Functions

### Description

**General Information.** Special Functions extend user control of the instrument beyond that normally available from dedicated front-panel keys. They are intended for the user who has an understanding of the instrument, and the service technician who needs arbitrary control of the instrument functions. Special Functions are accessed via HP-IB entry of the appropriate numeric code (refer to *Procedures* below). The codes comprise a prefix, decimal, and suffix. Special Functions are disabled by a variety of means, depending upon the function. Refer to the comprehensive listings below for actions which clear or disable any Special Function. Special Functions are grouped by their prefixes into three categories as follows:

#### Prefix 0

This is the Direct Control Special Function and is intended for use in servicing the Distortion Analyzer. All instrument error messages and safeguards are inactive. This is discussed in detail in Section 8. If the Direct Control is entered inadvertently, enter Automatic Operation (AU) over the HP-IB.

#### Prefixes 1 to 39

These are the User Special Functions which are used during normal instrument operation when a special configuration, a special measurement, or special information is required. All error messages and some safeguards remain in effect unless the operator disables them. These Special Functions are described below.

#### Prefixes 40 to 99

These are the Service Special Functions used to assist in troubleshooting an instrument fault. The functions available are quite diverse — special internal measurements, software control, and special service tests and configurations. Most instrument safeguards are relinquished. These Special Functions are discussed in detail in Section 8. If a Service Special Function is entered inadvertently, enter Automatic Operation (AU) over the HP-IB.

**Viewing Special Function States.** The operator-requested settings of Special Functions prefixed 1 through 8 may be viewed by pressing the S (Shift) Notch Tune keys once. This display is called the Special Display. If some of these Special Functions are in automatic modes (generally the 0-suffix setting), the actual instrument settings of these functions may be displayed by pressing the S (Shift) Notch Tune keys a second time while the Special Display is active. This display is called the Special Special Display. If desired, these displays can be cleared by pressing any key except the LCL or S (Shift) keys. A summary of User Special Functions is given on the following pages. Following the summary are procedures for using Special Display. These displays are also illustrated and explained.

#### NOTE

*The following special functions are ignored: 7.0SP, 7.1SP, 8.2SP, 10.0SP, 12.1SP through 12.9SP, 13.0SP, 13.1SP, and 17.1SP through 17.9SP. The instrument will accept the above HP-IB codes (with the possibility of an erroneous display), but they will not result in a measurement.*

Special Function Summary (1 of 3)

Special Function		HP-IB Code ↔ HP-IB ↔	Description	Disable		References and Comments
Name	Code			AUTO. OP.	CLEAR**	
Input Level Range (except DC level)	1.0	1.0SP	Automatic selection	—	—	Input Level Range (except DC Level)
	1.1	1.1SP	300V range	Y	N	
	1.2	1.2SP	189V range	Y	N	
	1.3	1.3SP	119V range	Y	N	
	1.4	1.4SP	75.4V range	Y	N	
	1.5	1.5SP	47.6V range	Y	N	
	1.6	1.6SP	30.0V range	Y	N	
	1.7	1.7SP	18.9V range	Y	N	
	1.8	1.8SP	11.9V range	Y	N	
	1.9	1.9SP	7.54V range	Y	N	
	1.10	1.10SP	4.76V range	Y	N	
	1.11	1.11SP	3.00V range	Y	N	
	1.12	1.12SP	1.89V range	Y	N	
	1.13	1.13SP	1.19V range	Y	N	
	1.14	1.14SP	0.754V range	Y	N	
	1.15	1.15SP	0.476V range	Y	N	
	1.16	1.16SP	0.300V range	Y	N	
	1.17	1.17SP	0.189V range	Y	N	
	1.18	1.18SP	0.119V range	Y	N	
1.19	1.19SP	0.0754V range	Y	N		
Input Level Range (DC Level only)	2.0	2.0SP	Automatic Selection	—	—	Input Level Range (DC Level only)
	2.1	2.1SP	300V range	Y	N	
	2.2	2.2SP	64V range	Y	N	
	2.3	2.3SP	16V range	Y	N	
	2.4	2.4SP	4V range	Y	N	
Post-Notch Gain	3.0	3.0SP	Automatic selection	—	—	Post-Notch Gain
	3.1	3.1SP	0 dB gain	Y	N	
	3.2	3.2SP	20 dB gain	Y	N	
	3.3	3.3SP	40 dB gain	Y	N	
	3.4	3.4SP	60 dB gain	Y	N	
Hold Decimal Point (right display only)	4.0	4.0SP	Automatic Selection	—	—	Hold Decimal Point  <sup>1</sup> Decimal Point not displayed.  <sup>2</sup> Leading zero not displayed. Shown to clarify decimal point position.
	4.1	4.1SP	DDDD.range <sup>1</sup>	Y	N	
	4.2	4.2SP	DDD.D range	Y	N	
	4.3	4.3SP	DD.DD range	Y	N	
	4.4	4.4SP	D.DDD range	Y	N	
	4.5	4.5SP	0.DDDD range <sup>2</sup>	Y	N	
	4.6	4.6SP	DD.DD mV range	Y	N	
	4.7	4.7SP	D.DDD mV range	Y	N	
	4.8	4.8SP	0.DDDD mV range <sup>2</sup>	Y	N	
Post-Notch Detector Filtering (except in SINAD)	5.0	5.0SP	Fast RMS Detector	—	—	Post-Notch Detector Response
	5.1	5.1SP	Slow RMS Detector	Y	N	
	5.2	5.2SP	Fast Average Detector	Y	N	
	5.3	5.3SP	Slow Average Detector	Y	N	

N = No; - = Not Applicable; Y = Yes; \*Except the LCL Keys \*\*The Clear Key Function.

Special Function Summary (2 of 3)

Special Function		HP-IB Code ↔ HP-IB ↔	Description	Disable		References and Comments
Name	Code			AUTO. OP.	CLEAR**	
Notch Tune	6.0	6.0SP	Automatic notch tuning	—	—	Notch Tune
	6.1	6.1SP	Hold notch tuning	Y	N	
Error Disable	8.0	8.0SP	All errors enabled	—	—	Error Disable
	8.1 or 8.3	8.1SP or 8.3SP	Disable Analyzer errors (Errors 12-17,31,and 96)	Y	N	
Hold Settings	9.0	9.0SP	Hold input level ranges, post-notch gain, decimal point and notch tuning at present settings.	Y	N	Hold Settings
Re-enter Ratio Mode	11.0	11.0SP	Restore last RATIO reference and enter RATIO mode if allowed.	N	N	RATIO and LOG/LIN
	11.1	11.1SP	Display RATIO reference	Y	Y	
Time Between Measurements	14.0	14.0SP	Minimum time between measurements	—	—	Time Between Measurement
	14.1	14.1SP	Add 1s between measurements	Y	N	
SINAD Display Resolution	16.0	16.0SP	0.01 dB above 25 dB;	—	—	SINAD
	16.1	16.1SP	0.5 dB below 25 dB 0.01 dB all ranges	Y	N	
Display Level in Watts	19.0	19.0SP	Display level as watts into 8Ω	Y	Y	Display Level in Watts
	19.NNN	19.NNNSP	Display level as watts into NNNΩ	Y	Y	
Read Display to HP-IB ↔ HP-IB ↔	20.0	20.0SP	Read right display	N	N	Read Display to HP-IB
	20.1	20.1SP	Read left display	N	N	
HP-IB Address ↔ HP-IB ↔	21.0	21.0SP	Displays HP-IB address (in binary) in left display; right display in form TLS where: T=1 means talk only; L=1 means listen only; S=1 means SRQ.	Y	Y	HP-IB Address
	21.1	21.1SP	Displays HP-IB address in decimal.			

N = No; - = Not Applicable; Y = Yes; \*Except the LCL Keys \*\*The Clear Key Function.

Special Function Summary (3 of 3)

Special Function		HP-IB Code ↔ HP-IB ↔	Description	Disable		References and Comments
Name	Code			AUTO. OP.	CLEAR**	
Service Request ↔ HP-IB ↔	22.N	22.NSP	Enable a condition to cause a service request, N is the sum of any combination of the weighted conditions below: 1—Data Ready 2—HP-IB error 4—Instrument error The instrument powers up in the 22.2 state (HP-IB error).	N	N	HP-IB Service Request Condition
N = No; - = Not Applicable; Y = Yes; *Except the LCL, S (Shift), and Numeric Keys **The Clear Key Function.						

**Procedure** **Entering Special Functions.** To use a special function, enter the corresponding HP-IB program code.

**Special Display.** To display the user-requested modes of Special Functions 1 through 8, press the S (Shift) key then the NOTCH TUNE key or enter the HP-IB code SP. The digit position (noted beneath the displays) corresponds to the special function prefix, and the number displayed in that position corresponds to the special function suffix.

**Special Special Display.** To determine the actual instrument settings of functions prefixed 1 through 8, press the S (Shift) key and the NOTCH TUNE key once while Special Display is active or enter the HP-IB code SS. (If the Special Display described above is not in effect, press the above mentioned keys twice to get this display.) The digit position corresponds to the function prefix, and the number displayed in that digit corresponds to the function suffix.

**Examples** **Entering Special Functions.** To set the post-notch gain to 40 dB:

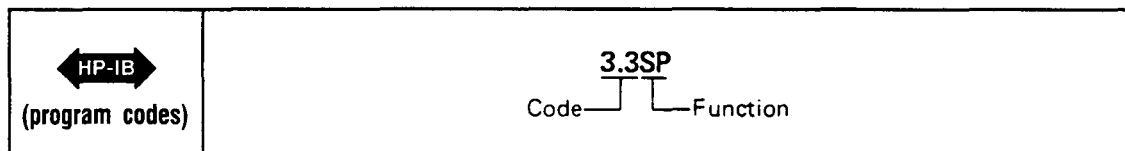

**Special Display.** When the S (Shift) and NOTCH TUNE keys are pressed, the following display results,

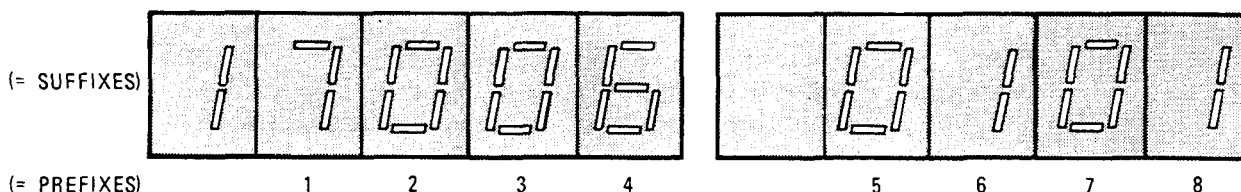

## Special Functions (Cont'd)

### Examples (cont'd)

This display indicates that the following Special Functions were selected by the operator:

Special Function		User-Requested Setting
Code	Name	
1.17	Input Level Range (Except DC Level)	0.189V range
2.0	Input Level Range (DC Level only)	Automatic Selection
3.0	Post-Notch Gain	Automatic Selection
4.6	Hold Decimal Point	DD.DD mV range (right display only)
5.0	Post-Notch Detector	Fast RMS Detector Filtering (Except in SINAD)
6.1	Notch Tune	Hold notch tuning
8.1	Error Disable	Disable analyzer errors

**Special Special Display.** When the S (Shift) and NOTCH TUNE keys are pressed again while the Special Display is active and the following display results, the actual instrument settings are tabulated below.

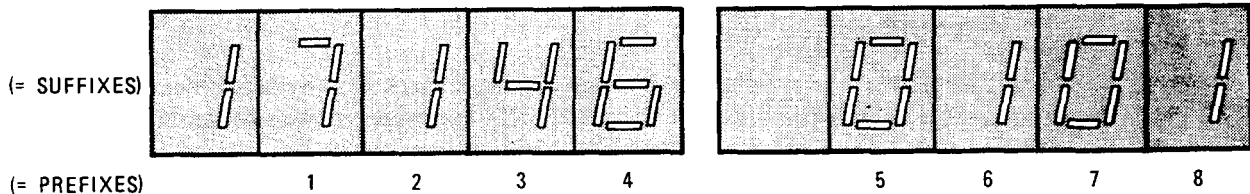

Special Function		Actual Instrument Setting
Code	Name	
1.17	Input Level Range (Except DC Level)	0.189V range
2.1	Input Level Range (DC Level only)	300V range
3.4	Post-Notch Gain	60 dB Range
4.6	Hold Decimal Point	DD.DD mV range
5.0	Post-Notch Detection Filtering	Fast RMS Detector (Except in SINAD)
6.1	Notch Tune	Hold notch tuning
8.1	Error Disable	Disable analyzer errors

**Program Code** HP-IB Codes for the special functions are summarized in the *Special Function Summary* above.



### Indications

Entering Special Functions. As the HP-IB program code is entered, both displays will blank, and the entered code will flash in the left display. Four dashes will momentarily appear in the right display, then are replaced with the appropriate reading for the selected measurement mode.

## Special Functions (Cont'd)

**Comments**

If a User Special Function (prefixes 1 to 39) has a suffix of zero, the zero need not be entered. For example, 5.0 SP equals 5. SP. (However, 1.1 SP does not equal 1.10 SP.) If when entering an HP-IB program code, Error 21 (invalid key sequence) is displayed, the special function requested has not been executed. Entry of invalid special function suffixes results in display of Error 23. For additional information on Direct Control Special Functions (prefix 0) or Service Special Functions (prefixes 40 to 99) refer to Section 8.

**Related Sections**

Automatic Operation  
Default Conditions and Power-up Sequence  
Special Function Summary table (under Description above)



## Time Between Measurements (Special Function 14)

**Description** A one-second delay between measurements can be added using Special Function 14. It can be used to allow the device under test to settle before making the measurement.

**Procedure** To add or delete the one second time delay between measurements, enter the corresponding HP-IB program code.

Time Delay Between Measurements	Program Code ↔ HP-IB ↔
Minimum	14.0SP
Add 1 second	14.1SP

**Example** To set a one second time delay between measurements:

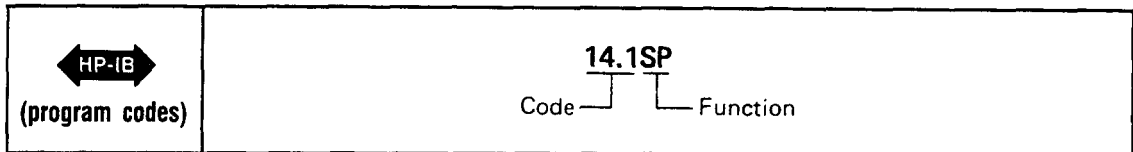

**Program Codes** For HP-IB codes, refer to *Procedure* above.

**Indications** As the program code is entered, both displays will blank and the entered code will flash in the left display. Both displays then return to the display that is appropriate for the currently selected measurement mode.

**Related Sections** Automatic Operation  
Special Functions

## Section 4

# PERFORMANCE TESTS

### 4-1. INTRODUCTION

The procedures in this section test the instrument's electrical performance using the specifications of Table 1-1 as the performance standards. All tests can be performed without access to the interior of the instrument. A simpler operational test is included in Section 3 under *Basic Functional Checks* (paragraph 3-10). The Basic Functional Checks also test the instrument's ability to function in the automatic mode (which is not thoroughly checked by the Performance Tests).

#### NOTE

*Unless otherwise noted, no warm-up period is required for these tests.*

*Line voltage must be within +5% and -10% of the specified input voltage (100, 120, 220, or 240 Vac) if the performance tests are to be considered valid.*

### 4-2. EQUIPMENT REQUIRED

Equipment required for the performance tests is listed in Table 1-3, *Recommended Test Equipment* in Section 1 of this manual. Any equipment that satisfies the critical specifications in the table may be substituted for the recommended model(s).

#### NOTE

*The performance tests are based on the assumption that the recommended test equipment is used. Substituting alternate test equipment may require modification of some procedures.*

### 4-3. TEST RECORD

Results of the performance tests may be tabulated on the Test Record shown in Table 4-1 at the end of the procedures. The Test Record lists all of the tested specifications and their acceptable limits. The results, recorded at incoming inspection, can be used for comparison in periodic maintenance and troubleshooting and after repairs or adjustments.

### 4-4. CALIBRATION CYCLE

This instrument requires periodic verification of performance. Depending on the use and environmental conditions, the instrument should be checked using the following performance tests at least once every year.

### 4-5. ABBREVIATED PERFORMANCE TESTING

No abbreviation of performance testing is recommended.

**PERFORMANCE TESTS**

**4-6. AC LEVEL ACCURACY PERFORMANCE TEST**

**SPECIFICATION:**

Characteristic	Performance Limits	Conditions
<b>AC LEVEL</b>		
Accuracy	±2% ±4% ±4%	50 mV to 300V; 20 Hz to 20 kHz 50 mV to 300V; 20 kHz to 100 kHz 0.3 mV to 50 mV; 20 Hz to 100 kHz

**DESCRIPTION:**

For each ac range, ac level accuracy is determined by measuring the output of an ac calibrator. In addition, for the lowest range, the output of an audio synthesizer is set to the lowest level of the just-completed calibration. This level is established as a ratio reference, then the signal is attenuated by a precise amount.

The procedure is run with the outer conductor of the input connector grounded, then with the inner conductor grounded and the signal applied to the (ungrounded) outer conductor.

A controller with HP-IB is recommended for this test since it provides the most convenient method for setting level ranges. However, an alternate method, not requiring a controller, is also mentioned in the procedure.

**WARNING**

*Voltages up to 300 Vrms will be applied to the Distortion Analyzer's input connector.*

**EQUIPMENT:**

- AC Calibrator ..... HP 754A and HP 746A, Datron 4200,  
..... or Fluke 5200A and Fluke 5215A
- Audio Synthesizer ..... HP 3336C
- Controller with HP-IB ..... HP 85B Opt 007
- Dual Banana to BNC Adapter ..... HP 10110B
- Dual Banana to BNC Adapter ..... HP 1251-2277

**PROCEDURE:**

**NOTE**

*The Distortion Analyzer's HP-IB address is assumed to be 728. All HP-IB commands are given in BASIC.*

**High-Level, High-Input AC Level Accuracy**

1. Connect the HP-IB controller to the Distortion Analyzer. Key in and execute the following command:

OUTPUT 728; "41.0SP L0"

to initialize the instrument and set the 80 kHz LOW PASS filter off.

**NOTE**

*If a controller is not being used, switch the Distortion Analyzer to off then back on. After power-up, press the 80 kHz LOW PASS to turn it off.*

**PERFORMANCE TESTS**

2. Set the Distortion Analyzer's INPUT switch to ground. Connect the ac calibrator to the Distortion Analyzer's INPUT.
3. Set the ac calibrator to the level indicated in the table. (Use the high voltage amplifier where needed.) Using the controller, key in and execute the Special Function and ratio commands indicated in the table below. Now set the ac calibrator to the frequency indicated in the table. The right display of the Distortion Analyzer should read within the limits indicated.

**NOTE**

*If a controller is not being used, proceed as follows:*

- a. Set the ac calibrator (level and frequency) as indicated.
- b. Press *S (Shift) NOTCH TUNE S (Shift) NOTCH TUNE*. In the left display, the digit or digits displayed in position 1 and the digit preceding it (if not blanked) should agree with the Special Function suffix of the controller command in the table. (For example, the display for 1.2SP should be 2 in position 1 (the preceding digit blank). The display for 1.12SP should be 12 with 2 in position 1 and 1 preceding it.)
- c. Press *AC LEVEL*. Compute the ratio of the reading in the right display to the calibrator setting. The ratio should be within the limits indicated in the table.

Controller Commands OUTPUT 728;	AC Calibrator		Ratio Limits (%)		
	Level (Vrms)	Frequency (Hz)	Minimum	Actual	Maximum
"1.1SP 300R1"	300	20	98	_____	102
		2 000	98	_____	102
		20 000	98	_____	102
		100 000	96	_____	104
"1.2SP 150R1"	150	100 000	96	_____	104
		20 000	98	_____	102
		2 000	98	_____	102
		20	98	_____	102
"1.3SP 100R1"	100	20	98	_____	102
		2 000	98	_____	102
		20 000	98	_____	102
		100 000	96	_____	104
"1.4SP 70R1"	70	100 000	96	_____	104
		20 000	98	_____	102
		2 000	98	_____	102
		20	98	_____	102
"1.5SP 45R1"	45	20	98	_____	102
		2 000	98	_____	102
		20 000	98	_____	102
		100 000	96	_____	104
"1.6SP 30R1"	30	100 000	96	_____	104
		20 000	98	_____	102
		2 000	98	_____	102
		20	98	_____	102

**PERFORMANCE TESTS**

Controller Commands OUTPUT 728;	AC Calibrator		Ratio Limits (%)		
	Level (Vrms)	Frequency (Hz)	Minimum	Actual	Maximum
"1.7SP 15R1"	15	20	98	_____	102
		2 000	98	_____	102
		20 000	98	_____	102
		100 000	96	_____	104
"1.8SP 10R1"	10	100 000	96	_____	104
		20 000	98	_____	102
		2 000	98	_____	102
		20	98	_____	102
"1.9SP 7R1"	7	20	98	_____	102
		2 000	98	_____	102
		20 000	98	_____	102
		100 000	96	_____	104
"1.10SP 4.5R1"	4.5	100 000	96	_____	104
		20 000	98	_____	102
		2 000	98	_____	102
		20	98	_____	102
"1.11SP 3R1"	3.0	20	98	_____	102
		2 000	98	_____	102
		20 000	98	_____	102
		100 000	96	_____	104
"1.12SP 1.5R1"	1.5	100 000	96	_____	104
		20 000	98	_____	102
		2 000	98	_____	102
		20	98	_____	102
"1.13SP 1R1"	1.0	20	98	_____	102
		2 000	98	_____	102
		20 000	98	_____	102
		100 000	96	_____	104
"1.14SP 0.7R1"	0.7	100 000	96	_____	104
		20 000	98	_____	102
		2 000	98	_____	102
		20	98	_____	102
"1.15SP 0.45R1"	0.45	20	98	_____	102
		2 000	98	_____	102
		20 000	98	_____	102
		100 000	96	_____	104
"1.16SP 0.3R1"	0.30	100 000	96	_____	104
		20 000	98	_____	102
		2 000	98	_____	102
		20	98	_____	102

**PERFORMANCE TESTS**

Controller Commands OUTPUT 728;	AC Calibrator		Ratio Limits (%)		
	Level (Vrms)	Frequency (Hz)	Minimum	Actual	Maximum
"1.17SP 0.15R1"	0.15	20	98	_____	102
		2 000	98	_____	102
		20 000	98	_____	102
		100 000	96	_____	104
"1.18SP 0.1R1"	0.10	100 000	96	_____	104
		20 000	98	_____	102
		2 000	98	_____	102
		20	98	_____	102
"1.19SP 0.07R1"	0.07	20	98	_____	102
		2 000	98	_____	102
		20 000	98	_____	102
		100 000	96	_____	104
"0.007R1"	0.007	100 000	96	_____	104
		20 000	96	_____	104
		2 000	96	_____	104
		20	96	_____	104

**High-Level, Low-Input AC Level Accuracy**

4. On the Distortion Analyzer, set the INPUT switch to FLOAT.
5. Connect the equipment as shown in Figure 4-1. Note how the cable connects to the Distortion Analyzer's input through the two adapters. The adapters reverse the outer and inner conductor connections to the cable.

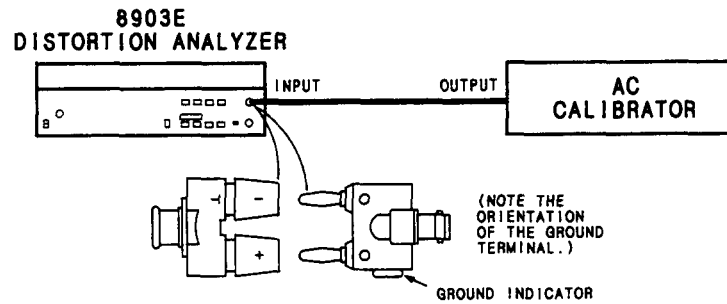

Figure 4-1. High-Level, Low-Input AC Level Accuracy Test Setup

**PERFORMANCE TESTS**

6. Set the ac calibrator to the level indicated in the table. (Use the high voltage amplifier as needed.) Using the controller, key in and execute the Special Function and ratio commands indicated in the table below. Now set the ac calibrator to the frequency indicated in the table. The right display of the Distortion Analyzer should read within the limits indicated.

**NOTE**

*If a controller is not being used, follow the procedure of the Note in step 3.*

Controller Commands OUTPUT 728;	AC Calibrator		Ratio Limits (%)		
	Level (Vrms)	Frequency (Hz)	Minimum	Actual	Maximum
"1.6SP 30R1"	30	100 000	96	_____	104
		20 000	98	_____	102
		2 000	98	_____	102
		20	98	_____	102
"1.7SP 15R1"	15	20	98	_____	102
		2 000	98	_____	102
		20 000	98	_____	102
		100 000	96	_____	104
"1.8SP 10R1"	10	100 000	96	_____	104
		20 000	98	_____	102
		2 000	98	_____	102
		20	98	_____	102
"1.9SP 7R1"	7	20	98	_____	102
		2 000	98	_____	102
		20 000	98	_____	102
		100 000	96	_____	104
"1.10SP 4.5R1"	4.5	100 000	96	_____	104
		20 000	98	_____	102
		2 000	98	_____	102
		20	98	_____	102
"1.11SP 3R1"	3.0	20	98	_____	102
		2 000	98	_____	102
		20 000	98	_____	102
		100 000	96	_____	104
"1.12SP 1.5R1"	1.5	100 000	96	_____	104
		20 000	98	_____	102
		2 000	98	_____	102
		20	98	_____	102
"1.13SP 1R1"	1.0	20	98	_____	102
		2 000	98	_____	102
		20 000	98	_____	102
		100 000	96	_____	104

**PERFORMANCE TESTS**

Controller Commands OUTPUT 728;	AC Calibrator		Ratio Limits (%)		
	Level (Vrms)	Frequency (Hz)	Minimum	Actual	Maximum
"1.14SP 0.7R1"	0.7	100 000	96	_____	104
		20 000	98	_____	102
		2 000	98	_____	102
		20	98	_____	102
"1.15SP 0.45R1"	0.45	20	98	_____	102
		2 000	98	_____	102
		20 000	98	_____	102
		100 000	96	_____	104
"1.16SP 0.3R1"	0.30	100 000	96	_____	104
		20 000	98	_____	102
		2 000	98	_____	102
		20	98	_____	102
"1.17SP 0.15R1"	0.15	20	98	_____	102
		2 000	98	_____	102
		20 000	98	_____	102
		100 000	96	_____	104
"1.18SP 0.1R1"	0.10	100 000	96	_____	104
		20 000	98	_____	102
		2 000	98	_____	102
		20	98	_____	102
"1.19SP 0.07R1"	0.07	20	98	_____	102
		2 000	98	_____	102
		20 000	98	_____	102
		100 000	96	_____	104
"0.007R1"	0.007	100 000	96	_____	104
		20 000	96	_____	104
		2 000	96	_____	104
		20	96	_____	104

**Low-Level, Low-Input AC Level Accuracy**

7. On the Distortion Analyzer, press the LCL key and set RATIO off.
8. Replace the ac calibrator with the audio synthesizer. (Leave the adapters as they are.) Set the audio synthesizer's level to approximately 7 mVrms as read on the Distortion Analyzer.
9. Set the audio synthesizer to the frequency indicated in the table below. For each setting, perform the following procedure:
  - a. Press RATIO if it is on. Set the audio synthesizer to 7 mVrms as read on the Distortion Analyzer. Press RATIO.
  - b. Decrease the level of the audio synthesizer by exactly 26 dB. Note the reading of the right display of the Distortion Analyzer.
  - c. Multiply the reading on the right display by the entry in the table of step 6, which corresponds to the



---

**PERFORMANCE TESTS**

---

ac calibrator setting of 0.007 Vrms at the current frequency. Divide the result by 100. The computed ratio should be within the limits indicated below. For example, if the reading in step b was 5.03% and the corresponding reading of step 6 is 101.5%, the computed result is

$$\frac{5.03\% \times 101.5\%}{100\%} = 5.11\%.$$

Synthesizer Frequency (Hz)	Displayed Reading of Step b (%)	Limits of Computed Result (%)		
		Minimum	Actual	Maximum
20	_____	4.81	_____	5.21
2 000	_____	4.81	_____	5.21
20 000	_____	4.81	_____	5.21
100 000	_____	4.81	_____	5.21

**Low-Level, High-Input AC Level Accuracy**

10. Remove the adapters from the Distortion Analyzer's INPUT. Connect the audio synthesizer's output directly to the Distortion Analyzer. Set the Distortion Analyzer's INPUT switch to ground.
11. Set the audio synthesizer to the frequency indicated in the table below. For each setting, perform the following procedure:
  - a. Press RATIO if it is on. Set the audio synthesizer to 7 mVrms as read on the Distortion Analyzer. Press RATIO.
  - b. Decrease the level of the audio synthesizer by exactly 26 dB. Note the reading of the right display of the Distortion Analyzer.
  - c. Multiply the reading on the right display by the entry in the table of step 3, which corresponds to the ac calibrator setting of 0.007 Vrms at the current frequency. Divide the result by 100.

Synthesizer Frequency (Hz)	Displayed Reading of Step b (%)	Limits of Computed Result (%)		
		Minimum	Actual	Maximum
100 000	_____	4.81	_____	5.21
20 000	_____	4.81	_____	5.21
2 000	_____	4.81	_____	5.21
20	_____	4.81	_____	5.21

**PERFORMANCE TESTS**

**4-7. DC LEVEL ACCURACY PERFORMANCE TEST**

**SPECIFICATION:**

Characteristic	Performance Limits	Conditions
DC LEVEL Accuracy	±0.75% of reading	400 mV to 300V
	±3 mV	<400 mV

**DESCRIPTION:**

The output from a dc standard is applied to the input of the Distortion Analyzer and the voltage on the display is compared against the output from the standard. The procedure is run with the outer conductor of the input connector grounded then with the inner conductor grounded and the signal applied to the (ungrounded) outer conductor.

**WARNING**

*Voltages up to 300 Vdc will be applied to the Distortion Analyzer's input connector.*

**EQUIPMENT:**

DC Standard ..... HP 740B, Datron 4000, or Fluke 893AR

**PROCEDURE:**

**High-Input DC Level Accuracy**

1. Switch the Distortion Analyzer off, then back on to initialize it. Set the INPUT switch to ground. Press S (Shift) DC LEVEL.
2. Connect the output of the dc standard to the INPUT of the Distortion Analyzer.
3. Set the dc standard to give the output voltage indicated below. For each setting, the right display on the Distortion Analyzer should read within the limits indicated.

DC Standard Voltage (Vdc)	DC Voltage Limits (Vdc)		
	Minimum	Actual	Maximum
300	297.75	_____	302.25
30	29.775	_____	30.225
3	2.9775	_____	3.0225
0.4	0.397	_____	0.403
0.04	0.037	_____	0.043

**Low-Input DC Level Accuracy**

4. On the Distortion Analyzer, set the INPUT switch to FLOAT.
5. Connect the equipment as shown in Figure 4-2. Note how the cable connects to the Distortion Analyzer's input through the two adapters. The adapters reverse the outer and inner conductor connections to the cable.

PERFORMANCE TESTS

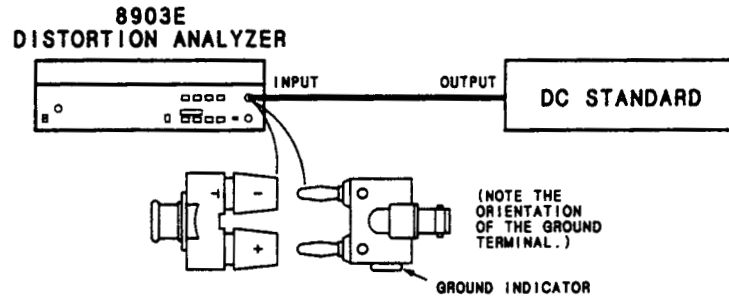

Figure 4-2. Low-Input DC Level Accuracy Test Setup

- Set the dc standard to give the output voltage indicated below. For each setting, the right display on the Distortion Analyzer should read within the limits indicated.

DC Standard Voltage (Vdc)	DC Voltage Limits (Vdc)		
	Minimum	Actual	Maximum
0.04	0.037	_____	0.043
0.4	0.397	_____	0.403
3	2.9775	_____	3.0225
30	29.775	_____	30.225

**PERFORMANCE TESTS**

**4-8. RESIDUAL DISTORTION AND NOISE PERFORMANCE TEST**

**SPECIFICATION:**

Characteristic	Performance Limits	Conditions
<b>DISTORTION AND SINAD</b>		
Residual Noise and Distortion	The higher of -80 dB or 15 $\mu$ V	20 Hz to 20kHz; 80 kHz bandwidth
	The higher of -70 dB or 45 $\mu$ V	20 kHz to 50 kHz; 500 kHz bandwidth
	The higher of -68 dB or 45 $\mu$ V	50 kHz to 100 kHz; 500 kHz bandwidth

**DESCRIPTION:**

The output of a low-distortion audio oscillator is connected to the Distortion Analyzer's input, and the combination of distortion and noise is measured at various frequencies and levels. The test measures the distortion and noise of the oscillator and analyzer simultaneously. If either instrument is out of specification, a known, good oscillator or analyzer can be substituted to determine which instrument is at fault.

**EQUIPMENT:**

Audio Oscillator . . . . . HP 339A or HP 8903B

**PROCEDURE:**

1. Switch the Distortion Analyzer off, then back on to initialize it. Set the INPUT switch to ground. Connect the output of the audio oscillator to the Distortion Analyzer's INPUT.
2. On the Distortion Analyzer, press **DISTN**. Set the audio oscillator frequency and level (open-circuit) and the Distortion Analyzer's **LP FILTER** as indicated below. For each setting, the right display should be within the limits indicated.

Audio Oscillator		LOW PASS FILTER	Limits (%)	
Frequency (Hz)	Level (V)		Actual	Maximum
20	3.0	80 kHz	_____	0.01
1 000	3.0	80 kHz	_____	0.01
1 000	2.5	80 kHz	_____	0.01
1 000	1.9	80 kHz	_____	0.01
1 000	0.3	80 kHz	_____	0.01
20 000	3.0	80 kHz	_____	0.01
50 000	3.0	Off	_____	0.03
50 000	0.3	Off	_____	0.03
100 000	3.0	Off	_____	0.04
100 000	2.5	Off	_____	0.04
100 000	1.9	Off	_____	0.04

**PERFORMANCE TESTS**

**4-9. DISTORTION AND SINAD ACCURACY PERFORMANCE TEST**

**SPECIFICATION:**

Characteristic	Performance Limits	Conditions
<b>DISTORTION</b>		
Accuracy	$\pm 1$ dB	20 Hz to 20 kHz
	$\pm 2$ dB	20 kHz to 100 kHz
<b>SINAD</b>		
Accuracy	$\pm 1$ dB	20 Hz to 20 kHz
	$\pm 2$ dB	20 kHz to 100 kHz

**DESCRIPTION:**

A signal with a known distortion level is created artificially by summing the outputs from two audio oscillators at the input of the Distortion Analyzer. The artificial distortion is then measured by the Distortion Analyzer. To calibrate the distortion, the second oscillator is set to a harmonic of the low-distortion oscillator, the two signals are set to a common reference level using an external voltmeter with a very flat frequency response, then the level of the second oscillator is attenuated to obtain a precise ratio.

**EQUIPMENT:**

- Audio Oscillator, Low-Distortion ..... HP 339A or HP 8903B
- Audio Oscillator ..... HP 3336C
- True RMS Voltmeter ..... HP 3403C

**PROCEDURE:**

1. Switch the Distortion Analyzer off, then back on to initialize it. Set the Distortion Analyzer controls as follows:

- INPUT switch ..... ground
- MEASUREMENT ..... DISTN
- LOG LIN ..... LOG

2. Connect the equipment as shown in Figure 4-3. The output impedance of both oscillators should be 50Ω. Set the voltmeter to read ac volts. Set the output of the low-distortion oscillator to 6V into an open circuit.

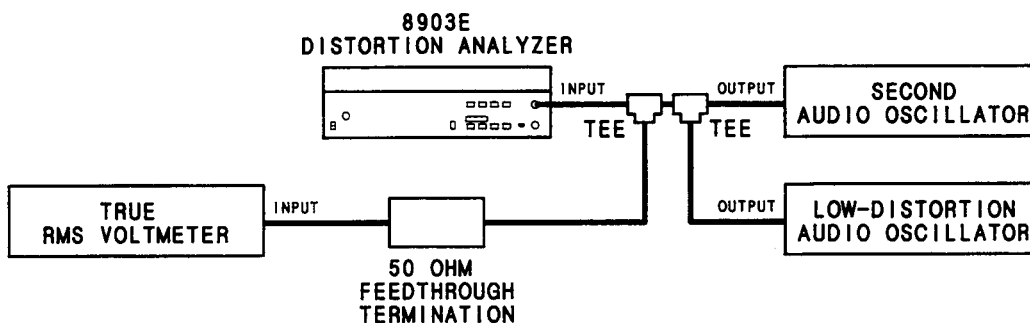

Figure 4-3. Distortion and SINAD Accuracy Test Setup

**PERFORMANCE TESTS**

3. Set the oscillator frequencies as indicated below. For each frequency setting, perform the following procedure:
  - a. Set the second oscillator level to minimum. Note the level of the output of the low-distortion oscillator on the external voltmeter.
  - b. Set the low-distortion oscillator amplitude to 0V. Adjust the second oscillator's level for the same reading as in step a.
  - c. Decrement (that is, attenuate) the second oscillator's output level as indicated.
  - d. Set the low-distortion oscillator level to 6V. The display on the Distortion Analyzer should read within the limits indicated.

Second Oscillator		Low-Distortion Oscillator Frequency (Hz)	Level (dB)		
Frequency (Hz)	Atten (dB)		Minimum	Actual	Maximum
50	10	25	-11.4	_____	-9.4
50	80	25	-81.0	_____	-79.0
4 000	10	2 000	-11.4	_____	-9.4
4 000	20	2 000	-21.0	_____	-19.0
4 000	30	2 000	-31.0	_____	-29.0
4 000	40	2 000	-41.0	_____	-39.0
4 000	50	2 000	-51.0	_____	-49.0
4 000	60	2 000	-61.0	_____	-59.0
4 000	70	2 000	-71.0	_____	-69.0
4 000	80	2 000	-81.0	_____	-79.0
6 000	80	2 000	-81.0	_____	-79.0
6 000	10	2 000	-11.4	_____	-9.4
8 000	10	2 000	-11.4	_____	-9.4
8 000	80	2 000	-81.0	_____	-79.0
10 000	80	2 000	-81.0	_____	-79.0
10 000	10	2 000	-11.4	_____	-9.4
40 000	10	20 000	-11.4	_____	-9.4
40 000	80	20 000	-81.0	_____	-79.0

4. On the Distortion Analyzer, set the 80 kHz LOW PASS FILTER off. Repeat step 3 for the settings indicated below.

Second Oscillator		Low-Distortion Oscillator Frequency (Hz)	Level (dB)		
Frequency (Hz)	Atten (dB)		Minimum	Actual	Maximum
200 000	10	100 000	-12.4	_____	-8.4
200 000	60	100 000	-62.0	_____	-58.0
300 000	60	100 000	-62.0	_____	-58.0
300 000	10	100 000	-12.4	_____	-8.4

**PERFORMANCE TESTS**

**4-10. FREQUENCY ACCURACY AND SENSITIVITY PERFORMANCE TEST**

**SPECIFICATION:**

Characteristic	Performance Limits	Conditions
<b>FREQUENCY</b>		
Measurement Range	20 Hz to 150 kHz 20 Hz to 100 kHz	AC level mode Distortion and SINAD modes
Accuracy	±0.004% ±1 digit	
Sensitivity	50 mV 5 mV	Distortion and SINAD modes AC level mode

**DESCRIPTION:**

The frequency of an audio synthesizer is measured at various levels with the Distortion Analyzer's counter.

**EQUIPMENT:**

Audio Synthesizer ..... HP 3336C

**NOTE**

*The audio synthesizer's time base accuracy must be 4 ppm or better.*

**PROCEDURE:**

1. Switch the Distortion Analyzer off then, back on to initialize it. Set the INPUT switch to ground. Set the 80 kHz LOW PASS FILTER off.
2. Connect the audio synthesizer's output to the Distortion Analyzer's INPUT.
3. Set the audio synthesizer frequency and level (open circuit) as indicated below. For each setting, the Distortion Analyzer's left display should agree with the frequency setting of the synthesizer to within the limits indicated. (If needed, the synthesizer level can be checked with the Distortion Analyzer in its ac level mode.)

Audio Synthesizer		MEASUREMENT Mode	Frequency Limits (Hz)		
Frequency (Hz)	Level (mV)		Minimum	Actual	Maximum
20	5	AC LEVEL	19.99	_____	20.01
20	50	DISTN	19.99	_____	20.01
99 900	50	DISTN	99 895	_____	99 905
99 900	5	AC LEVEL	99 895	_____	99 905
150 000	5	AC LEVEL	149 980	_____	150 020

---

**PERFORMANCE TESTS**

---

**4-11. AUDIO FILTERS PERFORMANCE TEST****SPECIFICATION:**

Characteristic	Performance Limits	Conditions
<b>AUDIO FILTERS</b>		
30 kHz Low-Pass Filter 3 dB Cutoff Frequency	30 kHz $\pm 2$ kHz	
80 kHz Low-Pass Filter 3 dB Cutoff Frequency	80 kHz $\pm 4$ kHz	
400 Hz High-pass Filter (Option 010 or 050) 3 dB Cutoff Frequency	400 Hz $\pm 40$ Hz	
CCITT Weighting Filter (Option 011 or 051) Deviation from Ideal Response <sup>(1)</sup>	$\pm 2$ dB $\pm 1$ dB $\pm 0.2$ dB $\pm 2$ dB $\pm 3$ dB	20 to 55°, 80% relative humidity 50 to 300 Hz 300 Hz to 3 kHz 800 Hz 3 to 3.5 kHz 3.5 to 5 kHz
CCIR Weighting Filter (Option 012 or 052) Deviation from Ideal Response <sup>(2)</sup>	$\pm 2$ dB $\pm 1$ dB $\pm 0.5$ dB $\pm 0.1$ dB $\pm 0.2$ dB $\pm 0.4$ dB $\pm 1$ dB $\pm 2$ dB	20 to 55°, 80% relative humidity 20 to 31.5 Hz 31.5 to 200 Hz 0.2 to 6.3 kHz 6.3 kHz 6.3 to 7.1 kHz 7.1 to 10 kHz 10 to 20 kHz 20 to 31.5 kHz
C-Message Weighting Filter (Option 013 or 053) Deviation from Ideal Response <sup>(3)</sup>	$\pm 0.1$ dB $\pm 1$ dB	20 to 55°, 80% relative humidity 1 kHz 60 Hz to 5 kHz
CCIR/ARM Weighting Filter (Option 014 or 054) Deviation from Ideal Response <sup>(4)</sup>	$\pm 1$ dB $\pm 0.5$ dB $\pm 0.1$ dB $\pm 0.2$ dB $\pm 0.4$ dB $\pm 1$ dB $\pm 2$ dB	20 to 55°, 80% relative humidity 31.5 to 200 Hz 200 Hz to 6.3 kHz 6.3 kHz 6.3 to 7.1 kHz 7.1 to 10 kHz 10 to 20 kHz 20 to 31.5 kHz

<sup>(1)</sup> See the International Telegraph and Telephone Consultative Committee (CCITT), Fifth Plenary Assembly, 1972, Telephone Transmission Quality, The International Telecommunication Union (1973), pp. 87-91. (CCITT Recommendation P53.)

<sup>(2)</sup> See the International Radio Consultative Committee (CCIR), Recommendations and Reports of the CCIR, 1978, Vol. X, pp. 162-163. (CCIR recommendation 409-3.)

<sup>(3)</sup> See the Bell System Technical Reference 41009, May 1975.

<sup>(4)</sup> See Dolby Laboratories Inc., Engineering Field Bulletin No. 19/4.



**PERFORMANCE TESTS**

Characteristic	Performance Limits	Conditions
<b>AUDIO FILTERS (Continued)</b>		
"A" Weighting Filter (Option 015 or 055) Deviation from Ideal Response <sup>(5)</sup>	±0.1 dB ±0.5 dB ±1 dB	20 to 55°, 80% relative humidity 1 kHz 20 Hz to 10 kHz 10 to 20 kHz
<sup>(5)</sup> See the American National Standard Specification for Sound Level Meters, 1971, pp. 8--10. (American National Standard S1.4-1971.)		

**DESCRIPTION:**

The output of the Distortion Analyzer is connected to the input. At various frequencies, the ac level of the output is measured with the audio filters in and out. The ratio of the two levels is the frequency response of the filter at that frequency.

**EQUIPMENT:**

Audio Synthesizer ..... HP 3336C  
Controller with HP-IB ..... HP 85B Opt 007

**PROCEDURE:**

**NOTE**

*The Distortion Analyzer's HP-IB address is assumed to be 728. All HP-IB commands are given in BASIC.*

1. Connect the HP-IB controller to the Distortion Analyzer. Key in and execute the following command:  
  
 OUTPUT 728; "41.0SP L0"  
  
 to initialize the instrument and set the 80 kHz LOW PASS FILTER off.
2. Set the Distortion Analyzer's INPUT switch to ground. Connect the audio synthesizer to the Distortion Analyzer's INPUT. Press the LCL key then set LOG/LIN to LOG.
3. Set the audio synthesizer's level to 2V into an open circuit and set its frequency as indicated below. For each setting, perform the following procedure:
  - a. Set all filters off. Set RATIO off.
  - b. Set RATIO on. Set in the filter as indicated below.
  - b. Note the dB ratio. If it is not between -3.01 and -2.99 dB, increment or decrement the audio synthesizer's frequency slightly until the indicated level is correct. The displayed frequency should be within the limits indicated.

**PERFORMANCE TESTS**

Initial SOURCE Frequency Setting (Hz)	High-Pass or Low-Pass Filter	Frequency Limits (Hz)		
		Minimum	Actual	Maximum
400*	400 Hz HP	360	_____	440
30 000	30 kHz LP	28 000	_____	32 000
80 000	80 kHz LP	76 000	_____	84 000

\* Option 010 or 050.

4. Key in and execute the following command on the controller:

OUTPUT 728; "48.1SP"

to enable up-ranging of the output gain. Press LCL. Set the audio synthesizer's frequency as indicated below in the table appropriate for the installed weighting filter. For each setting, perform the following procedure:

- a. Set all filters off. Set RATIO off.
- b. Set RATIO on. Select the appropriate weighting filter. The displayed ratio should be within the limits indicated.

*Table for CCITT Weighting Filter (Option 011 or 051)*

SOURCE Frequency (Hz)	Ratio Limits (dB)		
	Minimum	Actual	Maximum
50	-65.0	_____	-61.0
100	-43.0	_____	-39.0
200	-23.0	_____	-19.0
300	-11.6	_____	-9.6
500	-4.6	_____	-2.6
800	-0.2	_____	+0.2
1000	0.0	_____	+2.0
2000	-4.0	_____	-2.0
3000	-6.6	_____	-4.6
3500	-10.5	_____	-6.5
5000	-39.0	_____	-33.0

---

**PERFORMANCE TESTS**

---

*Table for CCIR Weighting Filter (Option 012 or 052)*

SOURCE Frequency (Hz)	Ratio Limits (dB)		
	Minimum	Actual	Maximum
31.5	-30.9	_____	-28.9
63	-24.9	_____	-22.9
100	-20.8	_____	-18.8
200	-14.3	_____	-13.3
400	-8.3	_____	-7.3
800	-2.4	_____	-1.4
1 000	-0.5	_____	+0.5
2 000	+5.1	_____	+6.1
3 150	+8.5	_____	+9.5
4 000	+10.0	_____	+11.0
5 000	+11.2	_____	+12.2
6 300	+12.1	_____	+12.3
7 100	+11.8	_____	+12.2
8 000	+11.0	_____	+11.8
9 000	+9.7	_____	+10.5
10 000	+7.7	_____	+8.5
12 500	-1.0	_____	+1.0
14 000	-6.3	_____	-4.3
16 000	-12.7	_____	-10.7
20 000	-23.2	_____	-21.2
31 500	-44.7	_____	-40.7

**PERFORMANCE TESTS**

*Table for C-Message Weighting Filter (Option 013 or 053)*

SOURCE Frequency (Hz)	Ratio Limits (dB)		
	Minimum	Actual	Maximum
60	-56.7	_____	-54.7
100	-43.5	_____	-41.5
200	-26.0	_____	-24.0
300	-17.5	_____	-15.5
400	-12.4	_____	-10.4
500	-8.5	_____	-6.5
600	-5.7	_____	-3.7
700	-3.7	_____	-1.7
800	-2.5	_____	-0.5
900	-1.6	_____	+0.4
1000	-0.1	_____	+0.1
1200	-1.2	_____	+0.8
1300	-1.5	_____	+0.5
1500	-2.0	_____	0.0
1800	-2.3	_____	-0.3
2000	-2.3	_____	-0.3
2500	-2.4	_____	-0.4
2800	-2.9	_____	-0.9
3000	-3.5	_____	-1.5
3300	-6.2	_____	-4.2
3500	-8.6	_____	-6.6
4000	-15.5	_____	-13.5
4500	-22.5	_____	-20.5
5000	-29.5	_____	-27.5

**PERFORMANCE TESTS**

*Table for CCIR/ARM Weighting Filter (Option 014 or 054)*

SOURCE Frequency (Hz)	Ratio Limits (dB)		
	Minimum	Actual	Maximum
31.5	-36.5	_____	-34.5
63	-30.5	_____	-28.5
100	-26.4	_____	-24.4
200	-19.9	_____	-18.9
400	-13.9	_____	-12.9
800	-8.0	_____	-7.0
1 000	-6.1	_____	-5.1
2 000	-0.5	_____	+0.5
3 150	+2.9	_____	+3.9
4 000	+4.4	_____	+5.4
5 000	+5.6	_____	+6.6
6 300	+6.5	_____	+6.7
7 100	+6.2	_____	+6.6
8 000	+5.4	_____	+6.2
9 000	+4.1	_____	+4.9
10 000	+2.1	_____	+2.9
12 500	-6.6	_____	-4.6
14 000	-11.9	_____	-9.9
16 000	-18.3	_____	-16.3
20 000	-28.8	_____	-26.8
31 500	-50.3	_____	-46.3

**PERFORMANCE TESTS**

*Table for "A" Weighting Filter (Option 015 or 055)*

SOURCE Frequency (Hz)	Ratio Limits (dB)		
	Minimum	Actual	Maximum
20	-51.0	_____	-50.0
25	-45.2	_____	-44.2
31.5	-39.9	_____	-38.9
40	-35.1	_____	-34.1
50	-30.7	_____	-29.7
63	-26.7	_____	-25.7
80	-23.0	_____	-22.0
100	-19.6	_____	-18.6
125	-16.6	_____	-15.6
160	-13.9	_____	-12.9
200	-11.5	_____	-10.5
250	-9.1	_____	-8.1
315	-7.1	_____	-6.1
400	-5.3	_____	-4.3
500	-3.7	_____	-2.7
630	-2.4	_____	-1.4
800	-1.3	_____	-0.3
1 000	-0.1	_____	+0.1
1 250	+0.1	_____	+1.1
1 600	+0.5	_____	+1.5
2 000	+0.7	_____	+1.7
2 500	+0.8	_____	+1.8
3 150	+0.7	_____	+1.7
4 000	+0.5	_____	+1.5
5 000	0.0	_____	+1.0
6 300	-0.6	_____	+0.4
8 000	-1.6	_____	-0.6
10 000	-3.0	_____	-2.0
12 500	-5.3	_____	-3.3
16 000	-7.6	_____	-5.6
20 000	-10.3	_____	-8.3

**PERFORMANCE TESTS**

**4-12. INPUT IMPEDANCE PERFORMANCE TEST**

**SPECIFICATION:**

Characteristic	Performance Limits	Conditions
<b>GENERAL</b>		
Input Impedance	100kΩ ±1%	Except dc level mode

**DESCRIPTION:**

An audio oscillator is connected to the Distortion Analyzer's input, and a ratio reference is set. A known impedance is then added in series with the input. The drop in level is a measure of the output or input impedance. The test is repeated with the audio oscillator connected to the analyzer's (ungrounded) outer conductor.

**NOTE**

*An arrangement of two BNC-to-clip lead adapters (such as HP 8120-1292) and a male-to-male BNC adapter (such as HP 1250-0216) provide a convenient way to insert the series resistor without stripping cables or soldering leads.*

**EQUIPMENT:**

- Audio Oscillator . . . . . HP 8903B or HP 3336C
- Dual Banana to BNC Adapter . . . . . HP 10110B
- Dual Banana to BNC Adapter . . . . . HP 1251-2277
- Resistor, 100kΩ . . . . . HP 0698-7497

**PROCEDURE:**

1. Switch the Distortion Analyzer off, then back on to initialize it. Set the INPUT switch to ground.
2. Set the audio oscillator to 3 Vrms at 100 Hz. Connect the audio oscillator's output to the Distortion Analyzer's INPUT. Press RATIO.
3. Insert the 100kΩ resistor in series with the center conductor of the audio oscillator's output. The right display should read between 49.90 and 50.40% if the audio oscillator has 600Ω output impedance, or between 49.00 and 51.00% if the audio oscillator has 50Ω output impedance.

Display with 600Ω Impedance: 49.90 \_\_\_\_\_ 50.40%  
 Display with 50Ω Impedance: 49.00 \_\_\_\_\_ 51.00%

4. On the Distortion Analyzer, set the INPUT switch to FLOAT.
5. Connect the equipment as shown in Figure 4-4. Note how the cable connects to the Distortion Analyzer's input through the two adapters. The adapters reverse the outer and inner conductor connections to the cable.





PERFORMANCE TESTS

4-13. COMMON-MODE REJECTION RATIO PERFORMANCE TEST

SPECIFICATION:

Characteristic	Performance Limits	Conditions
<b>GENERAL</b>		
Common Mode Rejection Ratio	>60 dB	Differential input <2V; 20 to 1000 Hz
	>50 dB	Differential input >2V; 20 to 1000 Hz
	>40 dB	1 to 20 kHz

DESCRIPTION:

The output from an external audio oscillator is connected to both inner and outer conductors of the Distortion Analyzer's input connector. The outer conductor is set to float. The ac level of the common-mode input is then measured for two different input ranges.

EQUIPMENT:

- Audio Oscillator . . . . . HP 8903B or HP 3336C
- Controller with HP-IB . . . . . HP 85B Opt 007
- Dual Banana to BNC Adapter . . . . . HP 10110B

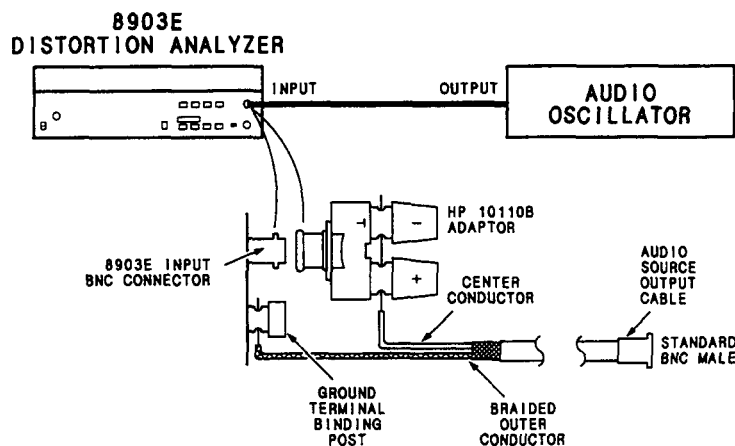

Figure 4-5. Common-Mode Rejection Ratio Test Setup

PROCEDURE

NOTE

The Distortion Analyzer's HP-IB address is assumed to be 728. All HP-IB commands are given in BASIC.

1. Connect the HP-IB controller to the Distortion Analyzer. Key in and execute the following command:  
 OUTPUT 728; "41.0SP"  
 to initialize the instrument. Set the Distortion Analyzer's INPUT switch to FLOAT.

**PERFORMANCE TESTS**

2. Set the audio oscillator to 1V at 20 Hz. The output impedance of the oscillator should be 600Ω.
3. Connect the equipment as shown in Figure 4-5. Note the use of the dual-banana-to-BNC adapters to tie the inner and outer conductors of the input connector together.

**NOTE**

*If desired, the connections can also be made using a variety of adapters and jumper cables in place of the stripped RF coaxial cable.*

4. Using the controller, key in and execute the Special Function indicated in the table below. Set the audio oscillator to the frequency listed. For each setting, the right display should read within the limits indicated.

Controller Commands OUTPUT 728;	Oscillator Frequency (Hz)	AC Level Limits (mV)	
		Actual	Maximum
"1.12SP"	20	_____	1.0
	1 000	_____	1.0
	20 000	_____	10.0
"1.1SP"	20 000	_____	10.0
	1 000	_____	3.2
	20	_____	3.2

Table 4-1. Performance Test Record (1 of 10)

Hewlett-Packard Company Model 8903E Audio Analyzer Serial Number _____				Tested by: _____ Date _____		
Para. No.	Test Description			Results		
				Minimum	Actual	Maximum
4-6.	<b>AC LEVEL ACCURACY PERFORMANCE TEST</b>					
	High-Level, High-Input AC Level Accuracy					
	Controller Commands OUTPUT 728; (SP)	AC Calibrator				
		Level (Vrms)	Frequency (Hz)			
	1.1	300	20	98%	_____	102%
			2 000	98%	_____	102%
			20 000	98%	_____	102%
			100 000	96%	_____	104%
	1.2	150	100 000	96%	_____	104%
			20 000	98%	_____	102%
			2 000	98%	_____	102%
			20	98%	_____	102%
	1.3	100	20	98%	_____	102%
			2 000	98%	_____	102%
			20 000	98%	_____	102%
			100 000	96%	_____	104%
	1.4	70	100 000	96%	_____	104%
			20 000	98%	_____	102%
			2 000	98%	_____	102%
			20	98%	_____	102%
1.5	45	20	98%	_____	102%	
		2 000	98%	_____	102%	
		20 000	98%	_____	102%	
		100 000	96%	_____	104%	
1.6	30	100 000	96%	_____	104%	
		20 000	98%	_____	102%	
		2 000	98%	_____	102%	
		20	98%	_____	102%	
1.7	15	20	98%	_____	102%	
		2 000	98%	_____	102%	
		20 000	98%	_____	102%	
		100 000	96%	_____	104%	
1.8	10	100 000	96%	_____	104%	
		20 000	98%	_____	102%	
		2 000	98%	_____	102%	
		20	98%	_____	102%	
1.9	7	20	98%	_____	102%	
		2 000	98%	_____	102%	
		20 000	98%	_____	102%	
		100 000	96%	_____	104%	
1.10	4.5	100 000	96%	_____	104%	
		20 000	98%	_____	102%	
		2 000	98%	_____	102%	
		20	98%	_____	102%	

Table 4-1. Performance Test Record (2 of 10)

Para. No.	Test Description		Results			
			Minimum	Actual	Maximum	
4-6. (Cont'd)	AC LEVEL ACCURACY PERFORMANCE TEST (Cont'd)					
	High-Level, High-Input AC Level Accuracy (Cont'd)					
	Controller Commands OUTPUT 728; (SP)	AC Calibrator				
		Level (Vrms)	Frequency (Hz)			
	1.11	3.0	20	98%	_____	102%
			2 000	98%	_____	102%
			20 000	98%	_____	102%
			100 000	96%	_____	104%
	1.12	1.5	100 000	96%	_____	104%
			20 000	98%	_____	102%
			2 000	98%	_____	102%
			20	98%	_____	102%
	1.13	1.0	20	98%	_____	102%
			2 000	98%	_____	102%
			20 000	98%	_____	102%
			100 000	96%	_____	104%
	1.14	0.7	100 000	96%	_____	104%
			20 000	98%	_____	102%
			2 000	98%	_____	102%
			20	98%	_____	102%
1.15	0.45	20	98%	_____	102%	
		2 000	98%	_____	102%	
		20 000	98%	_____	102%	
		100 000	96%	_____	104%	
1.16	0.30	100 000	96%	_____	104%	
		20 000	98%	_____	102%	
		2 000	98%	_____	102%	
		20	98%	_____	102%	
1.17	0.15	20	98%	_____	102%	
		2 000	98%	_____	102%	
		20 000	98%	_____	102%	
		100 000	96%	_____	104%	
1.18	0.10	100 000	96%	_____	104%	
		20 000	98%	_____	102%	
		2 000	98%	_____	102%	
		20	98%	_____	102%	
1.19	0.07	20	98%	_____	102%	
		2 000	98%	_____	102%	
		20 000	98%	_____	102%	
		100 000	96%	_____	104%	
	0.007	100 000	96%	_____	104%	
		20 000	98%	_____	102%	
		2 000	98%	_____	102%	
		20	98%	_____	102%	

Table 4-1. Performance Test Record (3 of 10)

Para. No.	Test Description			Results		
				Minimum	Actual	Maximum
4-6. Cont'd.	AC LEVEL ACCURACY PERFORMANCE TEST (Cont'd)					
	High-Level, Low-Input AC Level Accuracy					
	Controller Commands OUTPUT 728; (SP)	AC Calibrator				
		Level (Vrms)	Frequency (Hz)			
	1.6	30	100 000	96%	_____	104%
			20 000	98%	_____	102%
			2 000	98%	_____	102%
			20	98%	_____	102%
	1.7	15	20	98%	_____	102%
			2 000	98%	_____	102%
			20 000	98%	_____	102%
			100 000	96%	_____	104%
	1.8	10	100 000	96%	_____	104%
			20 000	98%	_____	102%
			2 000	98%	_____	102%
			20	98%	_____	102%
	1.9	7	20	98%	_____	102%
			2 000	98%	_____	102%
			20 000	98%	_____	102%
			100 000	96%	_____	104%
1.10	4.5	100 000	96%	_____	104%	
		20 000	98%	_____	102%	
		2 000	98%	_____	102%	
		20	98%	_____	102%	
1.11	3.0	20	98%	_____	102%	
		2 000	98%	_____	102%	
		20 000	98%	_____	102%	
		100 000	96%	_____	104%	
1.12	1.5	100 000	96%	_____	104%	
		20 000	98%	_____	102%	
		2 000	98%	_____	102%	
		20	98%	_____	102%	
1.13	1.0	20	98%	_____	102%	
		2 000	98%	_____	102%	
		20 000	98%	_____	102%	
		100 000	96%	_____	104%	
1.14	0.7	100 000	96%	_____	104%	
		20 000	98%	_____	102%	
		2 000	98%	_____	102%	
		20	98%	_____	102%	
1.15	0.45	20	98%	_____	102%	
		2 000	98%	_____	102%	
		20 000	98%	_____	102%	
		100 000	96%	_____	104%	

Table 4-1. Performance Test Record (4 of 10)

Para. No.	Test Description		Results			
			Minimum	Actual	Maximum	
4-6. (Cont'd)	<b>AC LEVEL ACCURACY PERFORMANCE TEST (Cont'd)</b>					
	<b>High-Level, Low-Input AC Level Accuracy (Cont'd)</b>					
	<b>Controller Commands OUTPUT 728; (SP)</b>	<b>AC Calibrator</b>				
		<b>Level (Vrms)</b>	<b>Frequency (Hz)</b>			
	1.16	0.30	100 000	96%	_____	104%
			20 000	98%	_____	102%
			2 000	98%	_____	102%
			20	98%	_____	102%
	1.17	0.15	20	98%	_____	102%
			2 000	98%	_____	102%
			20 000	98%	_____	102%
			100 000	96%	_____	104%
	1.18	0.10	100 000	96%	_____	104%
			20 000	98%	_____	102%
			2 000	98%	_____	102%
			20	98%	_____	102%
	1.19	0.07	20	98%	_____	102%
			2 000	98%	_____	102%
			20 000	98%	_____	102%
			100 000	96%	_____	104%
0.007		100 000	96%	_____	104%	
		20 000	98%	_____	102%	
		2 000	98%	_____	102%	
		20	98%	_____	102%	
<b>Synthesizer Frequency (Hz)</b>		<b>Displayed Reading of Step b (%)</b>				
<b>Low-Level, Low-Input AC Level Accuracy</b>						
20	_____	96%	_____	104%		
2 000	_____	96%	_____	104%		
20 000	_____	96%	_____	104%		
100 000	_____	96%	_____	104%		
<b>Low-Level, High-Input AC Level Accuracy</b>						
100 000	_____	96%	_____	104%		
20 000	_____	96%	_____	104%		
2 000	_____	96%	_____	104%		
20	_____	96%	_____	104%		

Table 4-1. Performance Test Record (5 of 10)

Para. No.	Test Description		Results		
			Minimum	Actual	Maximum
4-7.	<b>DC LEVEL ACCURACY PERFORMANCE TEST</b>				
	<b>High-Input DC-Level Accuracy</b>				
	<b>DC Standard Voltage</b>				
	300 Vdc		297.75 Vdc	_____	302.25 Vdc
	30 Vdc		29.775 Vdc	_____	30.225 Vdc
	3 Vdc		2.9775 Vdc	_____	3.0225 Vdc
	0.4 Vdc		0.397 Vdc	_____	0.403 Vdc
	0.04 Vdc		0.037 Vdc	_____	0.043 Vdc
	<b>Low-Input DC-Level Accuracy</b>				
	<b>DC Standard Voltage</b>				
0.04 Vdc		0.054 Vdc	_____	0.043 Vdc	
0.4 Vdc		0.594 Vdc	_____	0.403 Vdc	
3 Vdc		2.9775 Vdc	_____	3.0225 Vdc	
30 Vdc		29.775 Vdc	_____	30.225 Vdc	
300 Vdc		297.75 Vdc	_____	302.25 Vdc	
4-8.	<b>DISTORTION AND NOISE PERFORMANCE TEST</b>				
	<b>Audio Oscillator</b>		<b>LOW PASS FILTER</b>		
	<b>Frequency (Hz)</b>	<b>Level (V)</b>			
	20	3.0	80 kHz	_____	0.01%
	1 000	3.0	80 kHz	_____	0.01%
	1 000	2.5	80 kHz	_____	0.01%
	1 000	1.9	80 kHz	_____	0.01%
	1 000	0.3	80 kHz	_____	0.01%
	20 000	3.0	80 kHz	_____	0.01%
	50 000	3.0	Off	_____	0.03%
	50 000	0.3	Off	_____	0.03%
	100 000	3.0	Off	_____	0.04%
	100 000	2.5	Off	_____	0.04%
	100 000	1.9	Off	_____	0.04%

Table 4-1. Performance Test Record (6 of 10)

Para. No.	Test Description			Results		
				Minimum	Actual	Maximum
4-9.	<b>DISTORTION AND SINAD ACCURACY PERFORMANCE TEST</b>					
	Second Oscillator		Low-Distortion Oscillator Frequency (Hz)			
	Frequency (Hz)	Atten (dB)				
	Readings in step 3					
	50	10	25	-11.4 dB	_____	-9.4 dB
	50	80	25	-81.0 dB	_____	-79.0 dB
	4 000	10	2 000	-11.4 dB	_____	-9.4 dB
	4 000	20	2 000	-21.0 dB	_____	-19.0 dB
	4 000	30	2 000	-31.0 dB	_____	-29.0 dB
	4 000	40	2 000	-41.0 dB	_____	-39.0 dB
	4 000	50	2 000	-51.0 dB	_____	-49.0 dB
	4 000	60	2 000	-61.0 dB	_____	-59.0 dB
	4 000	70	2 000	-71.0 dB	_____	-69.0 dB
	4 000	80	2 000	-81.0 dB	_____	-79.0 dB
	6 000	80	2 000	-81.0 dB	_____	-79.0 dB
	6 000	10	2 000	-11.4 dB	_____	-9.4 dB
	8 000	10	2 000	-11.4 dB	_____	-9.4 dB
	8 000	80	2 000	-81.0 dB	_____	-79.0 dB
	10 000	80	2 000	-81.0 dB	_____	-79.0 dB
	10 000	10	2 000	-11.4 dB	_____	-9.4 dB
	40 000	10	20 000	-11.4 dB	_____	-9.4 dB
	40 000	80	20 000	-81.0 dB	_____	-79.0 dB
	Readings in step 4					
	200 000	10	100 000	-12.4 dB	_____	-8.4 dB
	200 000	60	100 000	-62.0 dB	_____	-58.0 dB
	300 000	60	100 000	-62.0 dB	_____	-58.0 dB
	300 000	10	100 000	-12.4 dB	_____	-8.4 dB



Table 4-1. Performance Test Record (7 of 10)

Para. No.	Test Description		Results			
			Minimum	Actual	Maximum	
4-10.	<b>FREQUENCY ACCURACY AND SENSITIVITY PERFORMANCE TEST</b>					
	<b>MEASUREMENT Mode</b>	<b>Audio Input</b>				
		<b>Level (mV)</b>	<b>Frequency (Hz)</b>			
	AC LEVEL	5	20	19.99	_____	20.01
	DISTN	50	20	19.99	_____	20.01
	DISTN	50	99 900	99 895	_____	99 905
AC LEVEL	5	99 900	99 895	_____	99 905	
AC LEVEL	5	150 00	149 980	_____	150 020	
4-11.	<b>AUDIO FILTERS PERFORMANCE TEST</b>					
	<b>High-Pass and Low-Pass Filters</b>					
	<b>Initial SOURCE Frequency Setting (Hz)</b>		<b>Filter</b>			
	400*		400 Hz HP	360 Hz	_____	440 Hz
	30 000		30 kHz LP	28 000 Hz	_____	32 000 Hz
	80 000		80 kHz LP	76 000 Hz	_____	84 000 Hz
	*Option 010 or 050					
	<b>SOURCE Frequency (Hz)</b>					
	<b>CCITT Weighting Filter (Option 011 or 051)</b>					
		50		-65.0 dB	_____	-61.0 dB
	100		-43.0 dB	_____	-39.0 dB	
	200		-23.0 dB	_____	-19.0 dB	
	300		-11.6 dB	_____	-9.6 dB	
	500		-4.6 dB	_____	-2.6 dB	
	800		-0.2 dB	_____	+0.2 dB	
	1 000		0.0 dB	_____	+2.0 dB	
	2 000		-4.0 dB	_____	-2.0 dB	
	3 000		-6.6 dB	_____	-4.6 dB	
	3 500		-10.5 dB	_____	-6.5 dB	
	5 000		-39.0 dB	_____	-33.0 dB	
	<b>CCIR Weighting Filter (Option 012 or 052)</b>					
	31.5		-30.9 dB	_____	-28.9 dB	
	63		-24.9 dB	_____	-22.9 dB	
	100		-20.8 dB	_____	-18.8 dB	
	200		-14.3 dB	_____	-13.3 dB	
	400		-8.3 dB	_____	-7.3 dB	
	800		-2.4 dB	_____	-1.4 dB	
	1 000		-0.5 dB	_____	+0.5 dB	
	2 000		+5.1 dB	_____	+6.1 dB	
	3 150		+8.5 dB	_____	+9.5 dB	

Table 4-1. Performance Test Record (8 of 10)

Para. No.	Test Description	Results		
		Minimum	Actual	Maximum
4-11 (Cont'd)	<b>AUDIO FILTERS PERFORMANCE TEST (Cont'd)</b>			
	<b>CCIR Weighting Filter (Option 012 or 052) (Cont'd)</b>			
	4 000	+10.0 dB	_____	+11.0 dB
	5 000	+11.2 dB	_____	+12.2 dB
	6 300	+12.1 dB	_____	+12.3 dB
	7 100	+11.8 dB	_____	+12.2 dB
	8 000	+11.0 dB	_____	+11.8 dB
	9 000	+9.7 dB	_____	+10.5 dB
	10 000	+7.7 dB	_____	+8.5 dB
	12 500	-1.0 dB	_____	+1.0 dB
	14 000	-6.3 dB	_____	-4.3 dB
	16 000	-12.7 dB	_____	-10.7 dB
	20 000	-23.2 dB	_____	-21.2 dB
	31 500	-44.7 dB	_____	-40.7 dB
	<b>C-Message Weighting Filter (Option 013 or 053)</b>			
	60	-56.7 dB	_____	-54.7 dB
	100	-43.5 dB	_____	-41.5 dB
	200	-26.0 dB	_____	-24.0 dB
	300	-17.5 dB	_____	-15.5 dB
	400	-12.4 dB	_____	-10.4 dB
	500	-8.5 dB	_____	-6.5 dB
	600	-5.7 dB	_____	-3.7 dB
	700	-3.7 dB	_____	-1.7 dB
	800	-2.5 dB	_____	-0.5 dB
	900	-1.6 dB	_____	+0.4 dB
	1 000	-0.1 dB	_____	+0.1 dB
	1 200	-1.2 dB	_____	+0.8 dB
	1 300	-1.5 dB	_____	+0.5 dB
	1 500	-2.0 dB	_____	0.0 dB
	1 800	-2.3 dB	_____	-0.3 dB
	2 000	-2.3 dB	_____	-0.3 dB
	2 500	-2.4 dB	_____	-0.4 dB
	2 800	-2.9 dB	_____	-0.9 dB
	3 000	-3.5 dB	_____	-1.5 dB
	3 300	-6.2 dB	_____	-4.2 dB
	3 500	-8.6 dB	_____	-6.6 dB
	4 000	-15.5 dB	_____	-13.5 dB
	4 500	-22.5 dB	_____	-20.5 dB
	5 000	-29.5 dB	_____	-27.5 dB
	<b>CCIR/ARM Weighting Filter (Option 014 or 054)</b>			
31.5	-36.5 dB	_____	-34.5 dB	
63	-30.5 dB	_____	-28.5 dB	
100	-26.4 dB	_____	-24.4 dB	
200	-19.9 dB	_____	-18.9 dB	
400	-13.9 dB	_____	-12.9 dB	
800	-8.0 dB	_____	-7.0 dB	
1 000	-6.1 dB	_____	-5.1 dB	

Table 4-1. Performance Test Record (9 of 10)

Para. No.	Test Description	Results		
		Minimum	Actual	Maximum
4-11 (Cont'd)	<b>AUDIO FILTERS PERFORMANCE TEST (Cont'd)</b>			
	<b>SOURCE Frequency (Hz) (Cont'd)</b>			
	<b>CCIR/ARM Weighting Filter (Option 014 or 054) (Cont'd)</b>			
	2 000	-0.5 dB	_____	+0.5 dB
	3 150	+2.9 dB	_____	+3.9 dB
	4 000	+4.4 dB	_____	+5.4 dB
	5 000	+5.6 dB	_____	+6.6 dB
	6 300	+6.5 dB	_____	+6.7 dB
	7 100	+6.2 dB	_____	+6.6 dB
	8 000	+5.4 dB	_____	+6.2 dB
	9 000	+4.1 dB	_____	+4.9 dB
	10 000	+2.1 dB	_____	+2.9 dB
	12 500	-6.6 dB	_____	-4.6 dB
	14 000	-11.9 dB	_____	-9.9 dB
	16 000	-18.3 dB	_____	-16.3 dB
	20 000	-28.8 dB	_____	-26.8 dB
	31 500	-50.3 dB	_____	-46.3 dB
	<b>"A" Weighting Filter (Option 015 or 055)</b>			
	20	-51.0 dB	_____	-50.0 dB
	25	-45.2 dB	_____	-44.2 dB
	31.5	-39.9 dB	_____	-38.9 dB
	40	-35.1 dB	_____	-34.1 dB
	50	-30.7 dB	_____	-29.7 dB
	63	-26.7 dB	_____	-25.7 dB
	80	-23.0 dB	_____	-22.0 dB
	100	-19.6 dB	_____	-18.6 dB
	125	-16.6 dB	_____	-15.6 dB
	160	-13.9 dB	_____	-12.9 dB
	200	-11.5 dB	_____	-10.5 dB
	250	-9.1 dB	_____	-8.1 dB
	315	-7.1 dB	_____	-6.1 dB
	400	-5.3 dB	_____	-4.3 dB
	500	-3.7 dB	_____	-2.7 dB
	630	-2.4 dB	_____	-1.4 dB
	800	-1.3 dB	_____	-0.3 dB
	1 000	-0.1 dB	_____	+0.1 dB
	1 250	+0.1 dB	_____	+1.1 dB
	1 600	+0.5 dB	_____	+1.5 dB
	2 000	+0.7 dB	_____	+1.7 dB
	2 500	+0.8 dB	_____	+1.8 dB
	3 150	+0.7 dB	_____	+1.7 dB
	4 000	+0.5 dB	_____	+1.5 dB
	5 000	0.0 dB	_____	+1.0 dB
	6 300	-0.6 dB	_____	+0.4 dB
	8 000	-1.6 dB	_____	-0.6 dB
	10 000	-3.0 dB	_____	-2.0 dB
	12 500	-5.3 dB	_____	-3.3 dB
	16 000	-7.6 dB	_____	-5.6 dB
	20 000	-10.3 dB	_____	-8.3 dB

Table 4-1. Performance Test Record (10 of 10)

Para. No.	Test Description		Results		
			Minimum	Actual	Maximum
4-12.	<b>INPUT IMPEDANCE PERFORMANCE TEST</b>				
	High Input Low Input		49.00% 49.00%	_____ _____	51.00% 51.00%
4-13.	<b>COMMON-MODE REJECTION RATIO PERFORMANCE TEST</b>				
	<b>Controller Commands OUTPUT 728; (SP)</b>	<b>Oscillator Frequency (Hz)</b>			
	1.12	20 1 000 20 000		_____ _____ _____	1mV 1mV 10.0 mV
1.1	20 000 1 000 20		_____ _____ _____	10.0 mV 3.2 mV 3.2 mV	

## Section 5

# ADJUSTMENTS

### 5-1. INTRODUCTION

This section contains adjustments and checks that assure peak performance of the Distortion Analyzer. The instrument should be readjusted after repair or failure to pass a performance test. Allow a 30 minute warm-up prior to performing the adjustments. Removing the instrument top cover and the internal shield cover is the only disassembly required for all adjustments.

To determine which performance tests and adjustments to perform after a repair, refer to paragraph 5-5, *Post-Repair Tests, Adjustments, and Checks*.

### 5-2. SAFETY CONSIDERATIONS

This section contains information, cautions, and warnings which must be followed for your protection and to avoid damage to the equipment.

#### WARNING

*Adjustments described in this section are performed with power supplied to the instrument and with protective covers removed. Maintenance should be performed only by service trained personnel who are aware of the hazard involved (for example, fire and electrical shock). Where maintenance can be performed without power applied, the power should be removed.*

### 5-3. EQUIPMENT REQUIRED

Most adjustment procedures contain a list of required test equipment. The test equipment is also identified by callouts in the test setup diagrams, where included.

If substitutions must be made for the specified test equipment, refer to Table 1-3 in Section 1 of this manual for the minimum specifications. It is important that the test equipment meet the critical specifications listed in the table if the Distortion Analyzer is to meet its performance requirements.

### 5-4. FACTORY-SELECTED COMPONENTS

Factory-selected components are identified on the schematics and parts list by an asterisk (\*) which follows the reference designator. The normal value or range of the components is shown. The Manual Changes supplement will provide updated information pertaining to the selected components. Table 5-1 lists the reference designator, the criteria used for selecting a particular value, the normal value range and the service sheet where the component part is shown.

### 5-5. POST-REPAIR TESTS, ADJUSTMENTS, AND CHECKS

Table 5-2 lists the performance tests, adjustments and checks needed to calibrate or verify calibration of a repaired assembly. The tests, adjustments and checks are classified by assembly repaired.

The table is also useful as a cross reference between performance tests and assemblies when the failure is a specification that is slightly out of limits.

After all repairs, perform the *Basic Functional Checks* (paragraph 3-10) and the *Internal Reference Frequency Adjustment* (paragraph 5-7). The Basic Functional Checks utilize automatic tuning and measurements which exercise nearly every circuit in the instrument (except the Remote Interface Assembly).

## 5-6. RELATED ADJUSTMENTS

The procedures in this section can be done in any order, but it is advisable to check the time base reference first.

Table 5-1. Factory Selected Components

Reference Designator	Service Sheet	Range of Values	Basis of Selection
A2C4 and A2C89	1	43 to 56 pF	See Input Flatness Adjustment (paragraph 5-8).
A2C9 and A2C102	1	6.2 to 7.5 pF	See Input Flatness Adjustment (paragraph 5-8).
A4R143 and A4R144	6	147 k $\Omega$ to infinity	See Voltmeter Adjustment (paragraph 5-13 or 14).

Table 5-2. Post-Repair Tests, Adjustments, and Checks

Assembly Repaired	Test, Adjustment, or Check	Ref. Para.
A1 Keyboard and Display Assembly	Power-Up Checks	8-27*
	Service Special Functions (Use 60.0 SPCL, Key Scan, and exercise all keys.)	8-23*
A2 Input Amplifier Assembly	AC Level Accuracy Performance Test	4-6
	DC Level Accuracy Performance Test	4-7
	Distortion and Noise Performance Test	4-8
	Audio Filters Performance Test	4-11
	Common-Mode Rejection Ratio Performance Test	4-13
	Input Flatness Adjustment	5-8
	Common-Mode Rejection Adjustment	5-9
400 Hz High-Pass and Weighting Bandpass Filters Adjustment	5-11	
A3 Notch Filter Assembly	Distortion and Noise Performance Test	4-8
	Notch Filter Tune and Balance Adjustment	5-12
A4 Output Amplifier/Voltmeter Assembly	AC Level Accuracy Performance Test	4-6
	DC Level Accuracy Performance Test	4-7
	Distortion and Noise Performance Test	4-8
	Distortion and SINAD Accuracy Performance Test	4-9
	Voltmeter Adjustment	5-13 or 14
A7 Latch Assembly	Basic Functional Checks	3-10
	Frequency Accuracy and Sensitivity Performance Test	4-10
	Power-Up Checks	8-27*
A8 Controller/Counter Assembly	Basic Functional Checks	3-10
	Frequency Accuracy and Sensitivity Performance Test	4-10
	Internal Reference Frequency Adjustment	5-7
	Power-Up Checks	8-27*
A9 Remote Interface Assembly	HP-IB Functional Checks	3-11
A10 Remote Interface Connector Assembly	Power-Up Checks	8-27*
A11 Series Regulator Socket Assembly	Basic Functional Checks	3-10
A12 Connector/Filter Assembly	Power-Up Checks	8-27*
A13 Power Supply and Mother Board Assembly		
A14 Line Power Module		

\* These paragraphs are found in the HP 8903B Service Manual.

**ADJUSTMENTS**

**5-7. INTERNAL REFERENCE FREQUENCY ADJUSTMENT**

**Reference:**

Service Sheet 15.

**Description:**

An oscilloscope, triggered by an external reference, is used to monitor the internal reference frequency while it is adjusted.

**Equipment:**

Frequency Standard ..... House Standard  
 Oscilloscope ..... HP 1740A

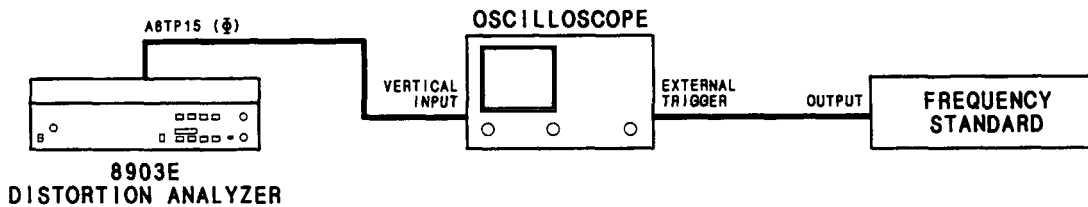

*Figure 5-1. Internal Reference Frequency Adjustment Test Setup*

**Procedure:**

1. Allow the equipment to warm up for 15 minutes.
2. Connect the equipment as shown in Figure 5-1. (The figure shows the setup for house-standard frequencies of 2 MHz or lower. If the frequency of the frequency standard is 5 or 10 MHz, reverse the vertical input and external trigger connections on the oscilloscope.)
3. Set the oscilloscope's vertical sensitivity to view the Distortion Analyzer's time base reference (or the frequency standard output). Set the horizontal scale for 0.1  $\mu$ s per division. Set the oscilloscope to trigger externally.
4. Adjust A8C27 for a waveform movement of 10 divisions per second or less. A totally non-metallic adjustment tool is recommended.

**NOTE**

*A movement of the waveform to the right (or left if the oscilloscope connections are reversed) at a rate of one division per second means that the Distortion Analyzer's time base frequency is low by 0.1 ppm.*

---

**ADJUSTMENTS**

---

**5-8. INPUT FLATNESS ADJUSTMENT****Reference:**

Service Sheet 1.

**Description:**

An ac calibrator is connected to the input of the Distortion Analyzer. The Distortion Analyzer is set to measure ac level. The frequency of the calibrator is varied between 1, 40, and 100 kHz and the flatness adjusted is for a constant level at all three frequencies. The procedure is repeated for two other input ranges. The entire procedure is run with the outer conductor of the input connector grounded, then with the inner conductor grounded and the signal applied to the (ungrounded) outer conductor.

**WARNING**

*Voltages up to 60 Vrms will be applied to the Distortion Analyzer's input connector and will be present on the assembly being adjusted. Do not extend the assembly or probe its circuitry when high voltage is applied to the input.*

**Equipment:**

AC Calibrator ..... HP 745A or Datron 4200 or Fluke 5200A  
 Dual Banana to BNC Adapter ..... HP 10110B  
 Dual Banana to BNC Adapter ..... HP 1251-2277

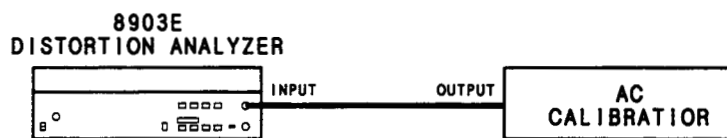

*Figure 5-2. High-Input Flatness Adjustment Test Setup*

**Procedure:****High-Input Flatness Adjustment**

1. Set the ac calibrator to 1 kHz at 4 Vrms.
2. Connect the equipment as shown in Figure 5-2.
3. Switch the Distortion Analyzer off, then back on to initialize it. Set the INPUT switch to ground. Set LP FILTER off.
4. The right display of the Distortion Analyzer should read between 3.9 and 4.1V. Check that the input is on range 10 by pressing S (Shift) NOTCH TUNE S (Shift) NOTCH TUNE. The first two digits of the left display should be 10. Press AC LEVEL. Press RATIO.
5. Set the ac calibrator frequency to 40 kHz. Adjust A2C3 (HIGH 12 DB) for a reading on the right display between 99.70 and 100.3%.



---

**ADJUSTMENTS**

---

6. Set the ac calibrator frequency to 100 kHz. Adjust A2C3 for a reading between 99.50 and 100.5%. Repeat steps 5 and 6 as often as needed until the flatness at 40 kHz and 100 kHz is within the limits given.

**NOTE**

*If the flatness cannot be adjusted so that the 40 kHz and 100 kHz readings are both within the given limits, change A2C4 as follows: If the 100 kHz reading is higher than at 40 kHz, decrease A2C4 by approximately 10%. If the 40 kHz reading is higher than that at 100 kHz, increase A2C4 by approximately 10%.*

7. On the Distortion Analyzer, press RATIO to turn it off.
8. Set the ac calibrator frequency to 1 kHz and level to 15 Vrms.
9. The right display of the Distortion Analyzer should read between 14.7 and 15.3V. Check that the input is on range 7 by pressing S (Shift) NOTCH TUNE S (Shift) NOTCH TUNE. The first digit of the left display should be 7. Press AC LEVEL. Press RATIO.
10. Set the ac calibrator frequency to 40 kHz. Adjust A2C10 (HIGH 24 DB) for a reading on the right display between 99.70 and 100.3%.
11. Set the ac calibrator frequency to 100 kHz. Adjust A2C10 for a reading between 99.50 and 100.5%. Repeat steps 10 and 11 as often as needed until the flatness at 40 kHz and 100 kHz is within the limits given.

**NOTE**

*If the flatness cannot be adjusted so that the 40 kHz and 100 kHz readings are both within the given limits, change A2C9 as follows: If the 100 kHz reading is higher than at 40 kHz, decrease A2C9 by approximately 10%. If the 40 kHz reading is higher than that at 100 kHz, increase A2C9 by approximately 10%.*

12. On the Distortion Analyzer, press RATIO to turn it off.
13. Set the ac calibrator frequency to 1 kHz and level to 60 Vrms.
14. The right display of the Distortion Analyzer should read between 58.8 and 61.2V. Check that the input is on range 4 by pressing S (Shift) NOTCH TUNE S (Shift) NOTCH TUNE. The first digit of the left display should be 4. Press AC LEVEL. Press RATIO.
15. Set the ac calibrator frequency to 40 kHz. Adjust A2C109 (HIGH 40 DB) for a reading on the right display between 99.70 and 100.3%.
16. Set the ac calibrator frequency to 100 kHz. Adjust A2C109 for a reading between 99.50 and 100.5%. Repeat steps 15 and 16 as often as needed until the flatness at 40 kHz and 100 kHz is within the limits given.

---

**ADJUSTMENTS**

---

**Low-Input Flatness Adjustment**

17. Set the ac calibrator to 1 kHz at 4 Vrms.
18. On the Distortion Analyzer, set the INPUT switch to FLOAT.
19. Connect the equipment as shown in Figure 5-3. Note how the cable connects to the Distortion Analyzer's input through the two adapters. The adapters reverse the outer and inner conductor connections to the cable.

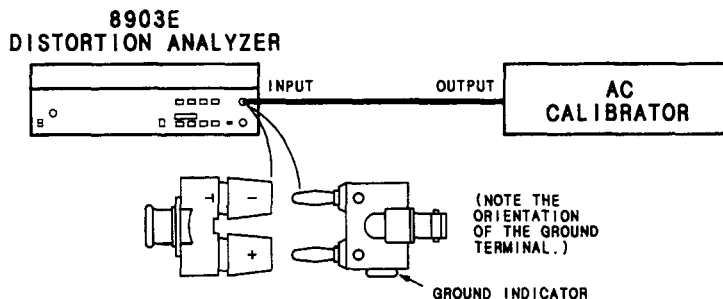

Figure 5-3. Low-Input Flatness Adjustment Test Setup

20. Switch the Distortion Analyzer off, then back on to initialize it. Set LP FILTER off.
21. The right display of the Distortion Analyzer should read between 3.9 and 4.1V. Check that the input is on range 10 by pressing S (Shift) NOTCH TUNE S (Shift) NOTCH TUNE. The first two digits of the left display should be 10. Press AC LEVEL. Press RATIO.
22. Set the ac calibrator frequency to 40 kHz. Adjust A2C90 (LOW 12 DB) for a reading on the right display between 99.70 and 100.3%.
23. Set the ac calibrator frequency to 100 kHz. Adjust A2C90 for a reading between 99.50 and 100.5%. Repeat steps 22 and 23 as often as needed until the flatness at 40 kHz and 100 kHz is within the limits given.

**NOTE**

*If the flatness cannot be adjusted so that the 40 kHz and 100 kHz readings are both within the given limits, change A2C89 as follows: If the 100 kHz reading is higher than at 40 kHz, decrease A2C89 by approximately 10%. If the 40 kHz reading is higher than that at 100 kHz, increase A2C89 by approximately 10%.*

24. On the Distortion Analyzer, press RATIO to turn it off.
  25. Set the ac calibrator frequency to 1 kHz and level to 15 Vrms.
  26. The right display of the Distortion Analyzer should read between 14.7 and 15.3V. Check that the input is on range 7 by pressing S (Shift) NOTCH TUNE S (Shift) NOTCH TUNE. The first digit of the left display should be 7. Press AC LEVEL. Press RATIO.
  27. Set the ac calibrator frequency to 40 kHz. Adjust A2C110 (HIGH 24 DB) for a reading on the right display between 99.70 and 100.3%.
-

---

**ADJUSTMENTS**

---

28. Set the ac calibrator frequency to 100 kHz. Adjust A2C110 for a reading between 99.50 and 100.5%. Repeat steps 27 and 28 as often as needed until the flatness at 40 kHz and 100 kHz is within the limits given.

**NOTE**

*If the flatness cannot be adjusted so that the 40 kHz and 100 kHz readings are both within the given limits, change A2C102 as follows: If the 100 kHz reading is higher than at 40 kHz, decrease A2C102 by approximately 10%. If the 40 kHz reading is higher than that at 100 kHz, increase A2C102 by approximately 10%.*

29. On the Distortion Analyzer, press RATIO to turn it off.
30. Set the ac calibrator frequency to 1 kHz and level to 60 Vrms.
31. The right display of the Distortion Analyzer should read between 58.8 and 61.2V. Check that the input is on range 4 by pressing S (Shift) NOTCH TUNE S (Shift) NOTCH TUNE. The first digit of the left display should be 4. Press AC LEVEL. Press RATIO.
32. Set the ac calibrator frequency to 40 kHz. Adjust A2C110 (HIGH 40 DB) for a reading on the right display between 99.70 and 100.3%.
33. Set the ac calibrator frequency to 100 kHz. Adjust A2C110 for a reading between 99.50 and 100.5%. Repeat steps 32 and 33 as often as needed until the flatness at 40 kHz and 100 kHz is within the limits given.
34. Perform the *AC Level Accuracy Performance Test* (paragraph 4-6).

---

**ADJUSTMENTS**

---

**5-9. COMMON-MODE REJECTION ADJUSTMENT****Reference:**

Service Sheet 1.

**Description:**

An audio oscillator, set to 1 V<sub>rms</sub> at 1 kHz, is connected to both the high and low (that is, the inner and outer conductor) inputs of the Distortion Analyzer. The low input is set to float. The common-mode, ac level is then adjusted for minimum response.

**Equipment:**

Audio Oscillator . . . . . HP 8903B or HP 3336C  
 Dual Banana to BNC Adaptor . . . . . HP 10110B

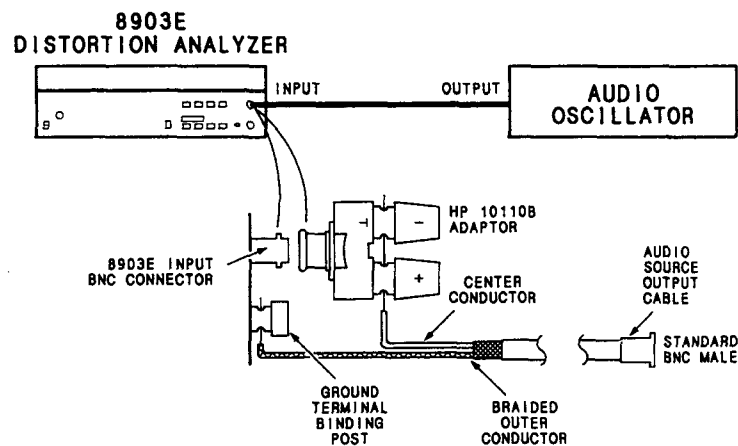

Figure 5-4. Common-Mode Rejection Adjustment Test Setup

**Procedure:**

1. Switch the Distortion Analyzer off, then back on to initialize it. Set the Distortion Analyzer's INPUT switch to FLOAT.
2. Set the audio oscillator to 1V at 1 kHz. The output impedance of the oscillator should be 600Ω.
3. Connect the equipment as shown in Figure 5-4. Note how the cable center conductor and shield are connected to the Distortion Analyzer INPUT connector and ground terminal.

**NOTE**

*If desired, the connections can also be made using a variety of adapters and jumper cables in place of the stripped RF coaxial cable.*

4. Adjust A2R43 (CM) for the minimum level on the right display, but less than 0.2 mV.
5. Perform the *Common-Mode Rejection Ratio Performance Test* (paragraph 4-13).

---

**ADJUSTMENTS**

---

**5-10. INPUT DC OFFSET ADJUSTMENT****Reference:**

Service Sheet 1.

**Description:**

With the Distortion Analyzer set to measure dc level and the input grounded, the dc offset is adjusted for a display of 0V.

**Equipment:**

Feedthrough Termination, 600 $\Omega$  ..... HP 11095A

**Procedure:**

1. Switch the Distortion Analyzer off, then back on to initialize it. Set the INPUT switch to ground. Set MEASUREMENT to DC LEVEL.
2. Connect the 600 $\Omega$  feedthrough (or a short circuit or a 50 $\Omega$  load) to the INPUT.
3. Adjust A2R44 (OFFSET) for a steady reading of -0.00V on the right display.

---

**ADJUSTMENTS**

---

**5-11. 400 HZ HIGH-PASS AND WEIGHTING BANDPASS FILTERS ADJUSTMENT****Reference:**

Service Sheet 2, 2A, and 2B.

**Description:**

An audio oscillator is connected to the input of the Distortion Analyzer. The oscillator is set to a specified frequency and a level reference is set. The filter to be adjusted is then inserted and its gain is adjusted for a level equal to the reference.

**Equipment:**

Audio Oscillator ..... HP 8903B or HP 3336C

**Procedure:****NOTE**

*In the following procedures, the left-most filter circuit board is designated A2A1 and the right-most board A2A2. The board location corresponds to option series 010 and 050 respectively.*

1. Switch the Distortion Analyzer off, then back on to initialize it. Set the INPUT switch to ground.
2. Set the audio oscillator amplitude to 1 Vrms and connect its output to the Distortion Analyzer's INPUT.
3. Perform the following steps for each filter installed.

**400 Hz High-Pass Filter (Option 010 or 050)**

- a. Set the weighting filter off, if on. Set RATIO off. Set the audio oscillator's frequency to 2 kHz. Set RATIO on.
- b. Press HIGH PASS 400 Hz. Adjust A2A1R6 or A2A2R6 (400 HZ) for a reading between 99.60 and 99.80% on the right display.
- c. Set the audio oscillator's frequency to 1 kHz. The right display should read between 99.00 and 101.0%.

**CCITT Weighting Filter (Option 011 or 051)**

- a. Set HIGH PASS 400 Hz or weighting filter off if on. Set the audio oscillator's frequency to 800 Hz. Set RATIO off. Set RATIO on.
- b. Press CCITT WEIGHTING. Adjust A2A1R4 or A2A2R4 (CCITT) for a steady reading of 100.0% on the right display.

**CCIR Weighting Filter (Option 012 or 052)**

- a. Set HIGH PASS 400 Hz or weighting filter off if on. Set the audio oscillator's frequency to 6300 Hz. Set RATIO off. Set RATIO on.
  - b. Press CCIR WEIGHTING. Adjust A2A1R7 or A2A2R7 (CCIR) for a steady reading of 407.4% (12.20 dB) on the right display.
-

---

**ADJUSTMENTS**

---

**C-Message Weighting Filter (Option 013 or 053)**

- a. Set HIGH PASS 400 Hz or weighting filter off if on. Set the audio oscillator's frequency to 1 kHz. Set RATIO off. Set RATIO on.
- b. Press C-MESSAGE WEIGHTING. Adjust A2A1R6 or A2A2R6 (CMSG) for a steady reading of 100.0% on the right display.

**CCIR/ARM Weighting Filter (Option 014 or 054)**

- a. Set HIGH PASS 400 Hz or weighting filter off if on. Set the audio oscillator's frequency to 6300 Hz. Set RATIO off. Set RATIO on.
- b. Press CCIR/ARM WEIGHTING. Adjust A2A1R7 or A2A2R7 (CCIR) for a steady reading of 213.8% (6.6 dB) on the right display.

**"A" Weighting Filter (Option 015 or 055)**

- a. Set HIGH PASS 400 Hz or weighting filter off if on. Set the audio oscillator's frequency to 1 kHz. Set RATIO off. Set RATIO on.
- b. Press "A" WEIGHTING. Adjust A2A1R3 or A2A2R3 (A-WTD) for a steady reading of 100.0% on the right display.

4. Perform the *Audio Filters Performance Test* (paragraph 4-11).

---

**ADJUSTMENTS**

---

**5-12. NOTCH FILTER TUNE AND BALANCE ADJUSTMENT****Reference:**

Service Sheet 4.

**Description:**

The Distortion Analyzer is set to measure the distortion from a clean audio oscillator. The output from the notch filter is observed on an oscilloscope while the tuning and balance are adjusted for a minimum. The measured distortion is also monitored on the amplitude display.

**Equipment:**

Audio Oscillator ..... HP 8903B or HP 339A  
 Oscilloscope ..... HP 1740A

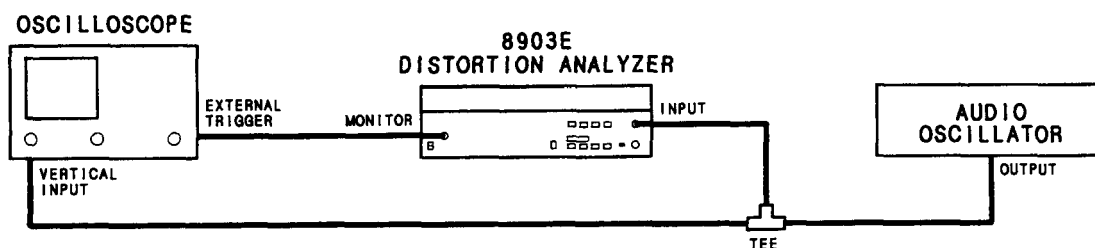

Figure 5-5. Notch Filter Tune and Balance Adjustment Test Setup

**Procedure:**

1. Switch the Distortion Analyzer off, then back on to initialize it. Set the INPUT switch to FLOAT. Set MEASUREMENT to DISTN. Set LOG LIN to LOG.
2. Set the audio oscillator to 2.8V at 1 kHz. Connect the equipment as shown in Figure 5-5.
3. Set the oscilloscope to view the ac signal at the MONITOR output. Set the oscilloscope's trigger to external.
4. Adjust A3R62 (TUNE OFFSET) and A3R63 (BAL OFFSET) for minimum signal and noise on the oscilloscope display.
5. Observe the right display of the Distortion Analyzer. It should read  $-90$  dB or less. Readjust the two adjustments to minimize the reading on the display which must be  $-90$  dB or less.

**NOTE**

*If the reading of step 5 cannot be brought within limit, it may be that the source has excessive distortion.*



**ADJUSTMENTS**

**5-13. VOLTMETER ADJUSTMENT (USING AN HP-IB CONTROLLER)**

**Reference:**

Service Sheets 6 and 7.

**Description:**

The Distortion Analyzer is set to measure the ac level from an audio oscillator. The internal ac-to-dc converter (as yet uncalibrated) produces a dc voltage that is read by the internal dc voltmeter and monitored by an external dc voltmeter. The sensitivity of the internal dc voltmeter is adjusted so that the amplitude display of the Distortion Analyzer agrees with the level measured by the external dc voltmeter.

The ac level from the audio oscillator is then monitored by an external ac voltmeter. The ac-to-dc converter is adjusted so that the amplitude display of the Distortion Analyzer agrees with the level measured by the external ac voltmeter at two different levels. Since there are two ac-to-dc converters, one true-rms responding and one average responding, two separate adjustments are made.

**NOTE**

*If an HP-IB controller is not available, use the next adjustment procedure, Voltmeter Adjustment (Not Requiring an HP-IB Controller).*

**Equipment:**

- Audio Oscillator ..... HP 8903B or HP 339A
- Controller with HP-IB ..... HP 85B Opt 007
- Digital Voltmeter ..... HP 3455A

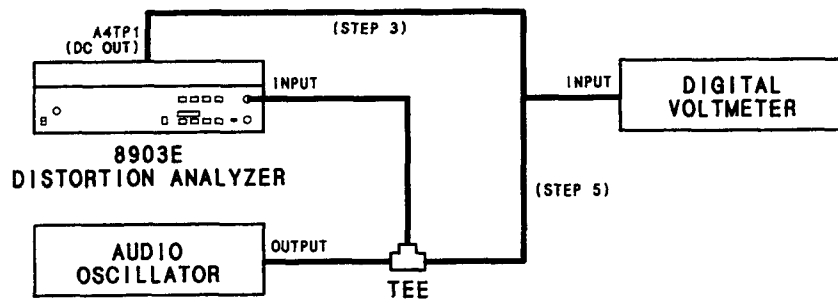

*Figure 5-6. Voltmeter Adjustment Test Setup*

**Procedure:**

**NOTE**

*The Distortion Analyzer's HP-IB address is assumed to be 728. All HP-IB commands are given in BASIC.*

1. Connect the HP-IB controller to the Distortion Analyzer. Key in and execute the following commands:

```
OUTPUT 728; "41.0SP 1.11SP 3.1SP"
OUTPUT 728; "49.3SP"
```

---

**ADJUSTMENTS**

---

to initialize the instrument, set the input range to 3V, set the post-notch amplifier gain to 0 dB, and read the output rms detector voltage directly.

**NOTE**

*The above commands should not be concatenated. A short waiting period between them is needed. If the HP-IB commands are to be put into a program, insert a 200 ms wait between the two output statements.*

2. Set the Distortion Analyzer's INPUT switch to ground.
  3. Set the audio oscillator to 3V at 1 kHz. Connect the equipment as shown in Figure 5-6. Connect the voltmeter to A4TP1 (DC OUT).
  4. Set the voltmeter to read dc volts. Adjust A4R125 (DC CAL) for a reading on the right display of the Distortion Analyzer that is the same as the reading on the voltmeter (within  $\pm 0.5$  mV). (See Service Sheet 7.)
  5. Connect the voltmeter to the INPUT of the Distortion Analyzer as shown in Figure 5-6. Set the voltmeter to read ac volts. On the Distortion Analyzer, press the LCL key, then set the MEASUREMENT mode to AC LEVEL.
  6. Adjust A4R91 (RMS SCALE) for a reading on the right display of the of the Distortion Analyzer that is the same as the reading on the ac voltmeter (within  $\pm 1$  mV). (See Service Sheet 6.)
  7. Set the audio oscillator level to 150 mV. On the Distortion Analyzer adjust A4R85 (RMS OFFSET) for a reading on the right display that is the same as the ac reading on the ac voltmeter (within  $\pm 0.5$  mV). (See Service Sheet 6.) If A4R85 does not have sufficient range, add or alter A4R143 or A4R144 as follows:
    - a. Unsolder A4R143 or A4R144, if present.
    - b. With a dc voltmeter, measure the voltage at the junction of A4R72 and A4C46.
    - c. If the voltage (ignoring polarity) is greater than 2 mV, compute  $R=1500/V$ , where V is the voltage measured (in volts).
    - d. Select a resistor which has a standard value resistance nearest R. If the measured voltage is negative, solder the new resistor in the location for A4R143; if positive, replace A4R144.
    - e. After a five-minute warm up, measure the voltage again which should be between  $-2$  and  $+2$  mVdc.
    - f. Repeat the adjustment of A4R85.
  8. Set the audio oscillator's level to 3V. Repeat steps 6 through 8 until the right display of the Distortion Analyzer and the ac voltmeter readings are the same within the limits stated in steps 6 and 7 for both 3V and 150 mV.
  9. On the Distortion Analyzer, press AVG to select the average-responding detector. Set the audio oscillator's level to 3V.
-

---

**ADJUSTMENTS**

---

10. Adjust A4R93 (AVG SCALE) for a reading on the right display of the Distortion Analyzer that is the same as the reading on the ac voltmeter (within  $\pm 1$  mV). (See Service Sheet 6.)
11. Set the audio oscillator's level to 150 mV. On the Distortion Analyzer, adjust A4R149 (AVG OFFSET) for a reading on the right display that is the same as the reading on the ac voltmeter (within  $\pm 0.5$  mV). (See Service Sheet 6.)
12. Set AMP TD to 3V. Repeat steps 10 through 12 until the right display of the Distortion Analyzer and the ac voltmeter are the same within the limits stated in steps 10 and 11 for both 3V and 150 mV.

---

**ADJUSTMENTS**

---

**5-14. VOLTMETER ADJUSTMENT (NOT REQUIRING AN HP-IB CONTROLLER)****Reference:**

Service Sheets 6 and 7.

**Description:**

The Distortion Analyzer is set to measure the ac level of an external audio oscillator. The ac signal at the oscillator's output is monitored by an external ac voltmeter. The ac-to-dc converter is adjusted so that its dc output agrees with the level measured by the external ac voltmeter at two different levels. Both the rms-responding and average-responding ac-to-dc converters are calibrated. The internal ac-to-dc converter produces a dc voltage that is read by the internal dc voltmeter and monitored by an external dc voltmeter. The sensitivity of the internal dc voltmeter is adjusted so that the amplitude display of the Distortion Analyzer agrees with the level measured by the external dc voltmeter.

**NOTE**

*If an HP-IB controller is available, this adjustment can be simplified using the previous adjustment procedure, Voltmeter Adjustment (Using an HP-IB Controller).*

**Equipment:**

Audio Oscillator . . . . . HP 8903B or HP 339A  
 Digital Voltmeter (A) . . . . . HP 3468A  
 Digital Voltmeter (B) . . . . . HP 3455A

**NOTE**

*Voltmeter A is optional. If one voltmeter is used, connect it, as required, between the points indicated in the procedure and Figure 5-7. Set it to read dc volts when connected to A4TP1 and ac volts when connected to the tee at the Distortion Analyzer's INPUT. Record the readings for comparison in subsequent steps.*

**Procedure:**

1. Switch the Distortion Analyzer off, then back on to initialize it. Set the INPUT switch to ground.
2. Connect the equipment as shown in Figure 5-7. Connect voltmeter B to A4TP1 (DC OUT) and set it to measure dc volts. Set voltmeter A to measure ac volts. Set the audio oscillator to 2.5 Vrms at 1 kHz.

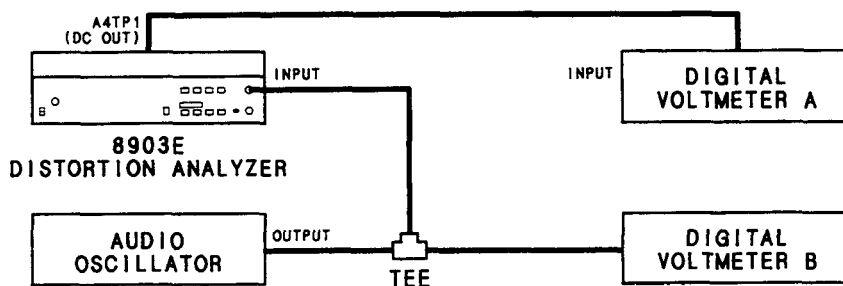

Figure 5-7. Voltmeter Adjustment Test Setup

---

**ADJUSTMENTS**

---

3. Press S (Shift) NOTCH TUNE S (Shift) NOTCH TUNE. The left display should read 11214.

**NOTE**

*Do not press any additional keys until step 8. This display must be present through step 7 in order to prevent instrument ranging.*

4. Set the audio oscillator to 3 Vrms at 1 kHz.
5. Adjust A4R91 (RMS SCALE) for a reading on voltmeter B that is the same as the reading on voltmeter A (within  $\pm 1$  mV). (See Service Sheet 6.)
6. Set the audio oscillator amplitude to 150 mV. Adjust A4R85 (RMS OFFSET) for a reading on voltmeter B that is the same as the reading on voltmeter A (within  $\pm 0.5$  mV). (See Service Sheet 6.) If A4R85 does not have sufficient range, add or alter A4R143 or A4R144 as follows:
- Unsolder A4R143 or A4R144 if present.
  - With a dc voltmeter, measure the voltage at the junction of A4R72 and A4C46.
  - If the voltage (ignoring polarity) is greater than 2 mV, compute  $R=1500/V$ , where V is the voltage measured (in volts).
  - Select a resistor which has a standard value resistance nearest R. If the measured voltage is negative, solder the new resistor in the location for A4R143; if positive, replace A4R144.
  - After a five-minute warm-up, measure the voltage again which should be between  $-2$  and  $+2$  mV dc.
  - Repeat the adjustment of A4R85.
7. Set the audio oscillator amplitude to 3V. Repeat steps 5 through 7 until the readings for voltmeter A and voltmeter B agree within the limits stated for both 3V and 150 mV.
8. On the Distortion Analyzer, select the averaging detector. Set the audio oscillator amplitude to 2.5V and key in S (Shift) NOTCH TUNE S (Shift) NOTCH TUNE. The left display should read 11214.

**NOTE**

*Do not press any additional keys until step 12. This display must be present through step 11.*

9. Set the audio oscillator amplitude to 3V. Adjust A4R93 (AVG SCALE) for a reading on voltmeter B that is the same as the reading on voltmeter A (within  $\pm 1$  mV). (See Service Sheet 6.)
10. Set the audio oscillator to 150 mV. Adjust A4R149 (AVG OFFSET) for a reading on voltmeter B that is the same as the reading on voltmeter A within  $\pm 0.5$  mV. (See Service Sheet 6.)
11. Set the audio oscillator amplitude to 3V. Repeat steps 9 and 10 until the readings for voltmeter A and voltmeter B agree within the limits stated for both 3V and 150 mV.
12. Press AC LEVEL. Set the audio oscillator to 3V at 1 kHz. Leave the Distortion Analyzer's detector in average.
13. Adjust A4R125 (DC CAL) until the right display of the Distortion Analyzer and voltmeter B agree (within  $\pm 0.5$  mV).
-